

# Pattison Family House Drainage Report

*Prepared for*

**Blaze Pope**  
8019 SE 20th Street  
Mercer Island, WA 98040

*Prepared by*

**Parametrix**  
1019 39th Avenue SE, Suite 100  
Puyallup, WA 98374  
T. 253.604.6600 F. 1.855.542.6353  
[www.parametrix.com](http://www.parametrix.com)



# CITATION

Parametrix, 2023. Pattison Family House Drainage Report.  
Prepared by Parametrix, Puyallup, Washington. September  
2023.

## CERTIFICATION

The technical material and data contained in this document were prepared under the supervision and direction of the undersigned, whose seal, as a professional engineer licensed to practice as such, is affixed below.

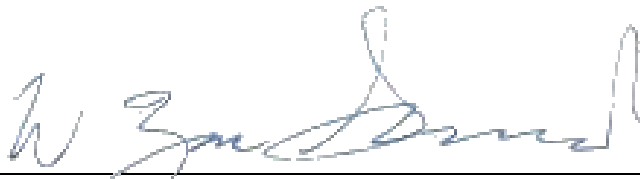

Prepared by Zac Garrard, EIT



Checked by Matt Craig, P.E.



Approved by Matt Craig, P.E.

This Page Intentionally Left Blank.



# TABLE OF CONTENTS

<b>1. INTRODUCTION .....</b>	<b>1</b>
<b>2. PROJECT OVERVIEW.....</b>	<b>1</b>
<b>3. EXISTING CONDITIONS .....</b>	<b>2</b>
3.1 Existing Site Hydrology.....	2
3.2 Geotechnical Investigation .....	2
3.3 Floodplain Analysis.....	2
<b>4. DEVELOPED SITE CONDITIONS.....</b>	<b>2</b>
4.1 Developed Site Hydrology.....	2
<b>5. OFF-SITE ANALYSIS.....</b>	<b>3</b>
5.1 Resource Review .....	3
5.2 Downstream Analysis.....	3
<b>6. MINIMUM REQUIREMENTS.....</b>	<b>4</b>
6.1 Requirement #1 Preparation of Stormwater Site Plan .....	4
6.2 Requirement #2 Construction Stormwater Pollution Prevention Plan (CSWPPP).....	4
6.3 Requirement #3 Source Control of Pollution.....	5
6.4 Requirement #4 Preservation of Natural Drainage Systems and Outfall .....	5
6.5 Requirement #5 On-Site Stormwater Management.....	5
6.6 Requirement #6 Runoff Treatment.....	6
6.7 Requirement #7 Flow Control.....	6
6.8 Requirement #8 Wetlands Protection .....	6
6.9 Requirement #9 Operations and Maintenance .....	6
<b>7. OTHER PERMITS &amp; FORMS .....</b>	<b>7</b>

## LIST OF FIGURES

Figure 1 Project Vicinity Map .....	1
-------------------------------------	---

## LIST OF TABLES

Table 1. Operation and Maintenance Plan.....	7
----------------------------------------------	---

## TABLE OF CONTENTS (CONTINUED)

### **APPENDICES**

- A Appendix A: NCRS Web Soil Survey
- B Appendix B: On – Site Detention Worksheet
- C Appendix C: Construction Stormwater Pollution Prevention Plan (CSWPPP)

## ACRONYMS AND ABBREVIATIONS

BMPs	best management practices
CFS	cubic feet per second
Ecology	Washington State Department of Ecology
EPSC	erosion prevention and sediment control
hrs	hours
LF	linear feet
LID	low-impact development
NPDES	National Pollutant Discharges Elimination System
NPGHS	Non-Pollution Generating Hard Surface
NRCS	National Resource Conservation Service
PGHS	Pollution Generating Hard Surfaces
ROW	right-of-way
SF	square feet
SWMMWW	Stormwater Management Manual for Western Washington
SWPPP	Stormwater Pollution Prevention Plan
TDA	Threshold Discharge Area
TMDL	Total Maximum Daily Loads
TSS	total suspended solids
WRIA	Water Resource Inventory Area
WWHM	Western Washington Hydrology Model



## 1. INTRODUCTION

This report is a drainage report has been prepared for Blaze Pope to be submitted to the City of Mercer Island Community Planning & Development Department. This report addresses the type of project proposed, the site's existing and developed hydrology, the analysis of off-site drainage as a result of the project completion, the stormwater quantity and quality treatment performance standards as required by the City of Mercer Island and the Washington State Department of Ecology.

## 2. PROJECT OVERVIEW

The project proposes to remodel and reconstruct an existing single-family residence with a new primary structure, new garage, and extension to an existing garage in Mercer Island within a quarter mile from Lake Washington and half-mile from downtown Mercer Island. Specifically, it is located on a corner lot off the intersection of SE 80th Avenue and SE 20th Street addressed as 8019 SE 20th St, Mercer Island, WA 98040, Parcel No. 544930-0065.



**Figure 1 Project Vicinity Map**

The new construction will include 5,000 square feet of residential space, 1,650 square feet of driveway surfaces, and 1,935 square feet of patio space. As part of the construction the City's stormwater network will extend a new main down SE 20<sup>th</sup> Street nearly 100 linear feet (LF). All runoff generated from the rooftop of the new structure will be collected and conveyed via roof drains into an on-site detention system before conveying into the new storm main before discharging into Lake Washington.

Construction activities of the proposed project will include:

- Clearing and demolishing the existing residential structure
- Excavating and pouring a foundation and stem walls for new the structure
- Framing the new structure and garage extension
- Constructing retaining walls
- Resurfacing the driveway

## 3. EXISTING CONDITIONS

The existing site is a single-family residence including a single-story structure with basement, two accessory garages, and patio space. Nearby land use includes single-family residences and accesses to boat docks along Lake Washington.

### 3.1 Existing Site Hydrology

The 0.43-acre lot is approximately 45% impervious surfaces with asphalt and rooftops hard surfaces with various landscaping plantings and trees aligning the perimeter of the property. Gutters align the rooftops of the existing structures, but it is not known where the downspout connect into whether it be on-site stormwater facilities or direct outfalls into the right-of-way. Any runoff collected in the landscape is presumed to infiltrate into the existing subgrade or sheet flow off-site.

The site is built within an existing hillside with foundation walls supporting the slope in some areas while additional rock walls retain in others. Slopes range from 5% up to 50%.

### 3.2 Geotechnical Investigation

A review of the United States Department of Agriculture Natural Resources Conservation Service's Web Soil Survey indicates that the site sits upon Kitsap silt loam and Puget silty clay loam. These soil layers are classified as Class C to C/D hydrologic soil groups, which have a slow rate of water transmission and susceptible to shrink-swell conditions.

Further details are outlined in Appendix A.

Furthermore, a review of the City of Mercer Island's Low Impact Development (LID) Feasibility Map indicates that infiltration facilities are not permitted within the property.

### 3.3 Floodplain Analysis

The project site does not lie within the mapped floodplain. The property is classified as an area of minimal flood hazard in Zone X.

## 4. DEVELOPED SITE CONDITIONS

The project proposes to remodel and reconstruct an existing single-family residence with a new primary structure, new garage, and extension to an existing garage in Mercer Island. The project will result with the building's roof covering majority of the existing site, which is assumed to be impervious.

For additional detail, see the site development drawings.

### 4.1 Developed Site Hydrology

The proposed project will build upon a developed graded site and residence. The new construction will include 5,000 square feet of residential space, 1,650 square feet of driveway surfaces, and 1,935 square feet of patio space. All runoff generated from the rooftop of the new structure will be collected and conveyed via roof drains into an on-site detention system before conveying into the new storm main

before discharging into Lake Washington. Existing grades and drainage patterns will be maintained as a result.

As part of the construction the City's stormwater network will extend a new main down SE 20<sup>th</sup> Street nearly 100 linear feet (LF). Runoff from resurfaced hard surface within the City's right-of-way will be graded to the edge of the pavement and collected in new public catch basins. There will be two new catch basins installed along SE 20<sup>th</sup> Street. Any roadway resurfacing will match into existing grades.

There is a possibility of run-on as a result of hill topography surrounding the site, but it is estimated to be limited due to the large tree cover and existing vegetation reducing the quantity of run-off.

All run-off generated from the proposed project within the site's limits and the surrounding road and walkways will be conveyed through the City's storm system where it will ultimately outfall in Lake Washington.

## 5. OFF-SITE ANALYSIS

The off-site analysis involves a resource review and downstream analysis. The resource review includes research and analysis of reports, maps, and recent studies to identify drainage basins, receiving waters, sensitive areas, and other information pertinent to the project site. Downstream analysis involves the investigation of impacts downstream of the site and the possible need to mitigate such impacts.

### 5.1 Resource Review

The site is located within the Cedar – Sammamish Watershed (WRIA 8) with many rivers, creeks, and tributaries outfalling into Lake Washington. As part of the WRIA 8 Salmon Recovery in conjunction with Ecology's stormwater management requirements, runoff generated from construction activities is subject to analysis to ensure the protection and quality of the State's surface waters. A review of city public storm systems indicate that the site and surrounding areas' runoff is conveyed through the storm system into Lake Washington.

Lake Washington is as a Flow Control – Exempt Surface Water which the project can be evaluated for exemption from flow control requirements per the City of Mercer Island Municipal Code and Ecology SWMMWW.

As aforementioned above, the site's northeast corner falls outside the FEMA floodplain.

### 5.2 Downstream Analysis

An analysis was conducted to determine if project construction will create any drainage problems downstream of the project limits. Runoff from pollution generating impervious surfaces collects natural pollutants as well as pollutants resulting from human activity and can discharge and deposit pollutants into waterbodies if not intercepted and treated. As such, treatment requirements will be considered as well.

The project was evaluated for exemption of flow control requirements due to its downstream outfall discharging directly to Lake Washington. It is noted that the ultimate outfall of the City's storm system is submerged in Lake Washington, which does restrict the discharge capacity of the City's system as opposed to an open to the atmosphere outfall. The extent of this reduction is not known, however.

The developed project will result in minimal variation from the existing developed characteristics, and likewise have minimal impacts in the volume of runoff generated from project completion. All run-off generated from the project's roofs – a non-pollution generating impervious surface – will be tight-lined into a proposed on-site detention pipe via a dedicated storm line from the gutters.

The installation of a detention pipe will provide on-site stormwater management for the run-off generated from the property. The quantity of runoff is estimated to be similar to existing developed conditions. The detention pipe will have a control structure reducing the discharge rate from the facility dictated by orifices at varying sizes and elevations. As such, there are no estimated downstream impacts as a result of the project.

## 6. MINIMUM REQUIREMENTS

The Pattison Family House project meets the definition of redevelopment and proposes to add/replace over 5,000 SF of impervious surface and land disturbing activity. The entire project site is evaluated for Minimum Requirements 1-9 applicable for all new PGHS and NPGHS constructed as a result of project completion.

### 6.1 Requirement #1 Preparation of Stormwater Site Plan

Preparation of this stormwater management plan in accordance with the SWMMWW outlines and satisfies this criterion. The proposed development activities are indicated in the Pattison Family House civil design plan set submitted separately. Stormwater elements are outlined within this report in conjunction with the plan set.

### 6.2 Requirement #2 Construction Stormwater Pollution Prevention Plan (CSWPPP)

These thirteen erosion control requirements below must be met evaluated for the project applicability and implemented prior to and during any ground-clearing and construction activities:

1. Mark Clearing Limits
2. Establish Construction Access
3. Control Flow Rates
4. Install Sediment Controls
5. Stabilize Soils
6. Protect Slopes
7. Protect Drain Inlets
8. Stabilize Channels and Outlets
9. Control Pollutants
10. Control Dewatering
11. Maintain BMPs
12. Manage the Project
13. Protect Low Impact Development BMPs (Infiltration BMPs)

An erosion control plan and CSWPPP will be reviewed prior to any construction activities. BMPs will be included in the CSWPPP with necessary details to meet the thirteen CSWPPP elements. It is the contractor's responsibility to follow the CSWPPP, utilize the BMPs indicated throughout the duration of the project's completion, and maintain an updated CSWPPP on-site for reference as amendments are incorporated.



## 6.3 Requirement #3 Source Control of Pollution

The source-control BMPs listed below give a broad overview of measures that will be taken to prevent stormwater from coming into contact with pollutants on-site, both during and after construction activities:

To minimize dust generation during construction, soil will be wetted down with water prior to ground disturbance. All generated waste must be disposed of properly.

Perimeter erosion control measures shall be installed to retain sediment and other pollutants within the site limits. Existing catch basins with the project vicinity shall have inlet protection measures installed to provide secondary protection from polluted stormwater entering the City's storm main system.

Loose aggregate chunks and dust will be swept or shoveled and collected (not hosed down a storm drain) for recycling or proper disposal.

## 6.4 Requirement #4 Preservation of Natural Drainage Systems and Outfall

Natural drainage patterns and discharges from the project site at the natural location will be maintained to the maximum extent practicable.

All runoff from the site will be conveyed into the City's storm system as it currently does. The adjacent roadway will maintain its existing grades as a result of the project as well.

## 6.5 Requirement #5 On-Site Stormwater Management

The project site conveys runoff into the City's storm system that ultimately outfalls into Lake Washington. The lake is classified as an Exempt Surface Water, but it is noted that the ultimate outfall of the City's storm system is submerged in Lake Washington, which does restrict the discharge capacity of the City's system as opposed to an open to the atmosphere outfall. As such, on-site stormwater management must be provided on-site.

Per SWMMWW Vol. I Section 2.5.5 and Figure 2.5.1, projects that are exempt from on-site flow control do not have to achieve the LID performance standard, nor consider bioretention, rain gardens, permeable pavement, and full dispersion if using List #1 or List #2. However, the project must consider implementing BMPs T5.13 Post-Construction Soil Quality and Depth, BMP T5.10 A,B,C, for downspout infiltration, dispersion systems, or perforated stub-out connections, and BMP T5.11 or T5.12: Concentrated Flow Dispersion or Sheet Flow Dispersion, to the maximum extent feasible.

The project cannot feasibly implement some of the aforementioned BMPs in part due to the tight site constraints, steep slopes, and poor soil conditions that does not support implementing downspout BMPs, rain gardens or bioretention, or concentrated/sheet flow dispersion from the site without adverse impacts on the surrounding properties or public ROW. However, post-construction soil quality and depths BMPs will be implemented in landscaped areas.

Per the City of Mercer Island on-site detention requirements, the project will implement on-site detention due to the capacity constraint on the City's storm system. The installation of a detention pipe will provide on-site stormwater management for the run-off generated from the property.

## 6.6 Requirement #6 Runoff Treatment

The project will result in new and replaced impervious surfaces distributed between rooftops, patios, and driveways. Runoff treatment must be evaluated for projects that result in 5,000 SF of pollution generating hard surfaces per the City of Mercer Island standards. The Pattison Family House project proposes approximately 1,650 SF of PGHS and by resurfacing and regrading the driveway, and it will not be required to provide treatment for runoff from this contributing area.

Additionally, the project will have a rooftop covering the majority of the site. The roof is classified as a non-pollution generating impervious surface (NPGHS) and will generate stormwater runoff, which does not require additional water quality treatment before discharging off-site. This runoff will be tightlined to an on-site detention system prior to discharging into the City's storm system.

## 6.7 Requirement #7 Flow Control

The installation of a detention pipe will provide on-site stormwater management for the run-off generated from the property. The proposed on-site detention pipe will have a control structure reducing the discharge rate from the facility dictated by orifices at varying sizes and elevations as specified by the City's On-Site Detention System table and worksheet. The quantity of runoff is estimated to be similar to existing developed conditions, but the flow control structure within the detention pipe will reduce the off-site discharge rate prior to outfalling into the City's storm system.

For further details, see the Appendix B for the On – Site Detention Worksheet.

## 6.8 Requirement #8 Wetlands Protection

There are no wetlands in the immediate vicinity of the project site.

## 6.9 Requirement #9 Operations and Maintenance

The proposed stormwater conveyance system located on private property will be the property owner's responsibility for their operation and maintenance. Common maintenance tasks for the stormwater facilities are listed in Table 1.

**Table 1. Operation and Maintenance Plan**

Facility	Frequency	Maintenance
Conveyance Systems	Annually and major storm event	<ul style="list-style-type: none"> <li>• Use rodding to clear any root invasion.</li> <li>• Replace damaged pipes with dents or punctures that impact performances.</li> <li>• Remove vegetation that reduces free movement of water through pipes.</li> <li>• Flush pipe networks from cleanouts to clear debris.</li> </ul>
Catch Basin	Biannually and major storm event	<ul style="list-style-type: none"> <li>• Dry sweep the parking lots and access drives at least every 6 months to reduce accumulation of sediments and debris.</li> <li>• Clean and dispose of trapped sediments from sump at least every 6 months and after major storms.</li> <li>• Dispose of any debris or accumulated sediment properly, according to federal, state, and local jurisdictions.</li> </ul>
Detention Pipe	Biannually and major storm event	<ul style="list-style-type: none"> <li>• Clean and dispose of trapped sediments and debris from sump at least every 6-12 months and after major storms by hand or vac-truck.</li> <li>• Clear the air vent if blockage occurs.</li> <li>• Replace orifice plate if damage, bends, or blockage if the control device is not operating properly.</li> </ul>

## 7. OTHER PERMITS & FORMS

Additional permits required or anticipated for this project are listed below.

- Building Permit
- Site Development Worksheet
- Tree Inventory & Replacement Worksheet

Appendix A:  
NCRS Web Soil Survey





United States  
Department of  
Agriculture

**NRCS**

Natural  
Resources  
Conservation  
Service

A product of the National  
Cooperative Soil Survey,  
a joint effort of the United  
States Department of  
Agriculture and other  
Federal agencies, State  
agencies including the  
Agricultural Experiment  
Stations, and local  
participants

# Custom Soil Resource Report for King County Area, Washington



# Preface

---

Soil surveys contain information that affects land use planning in survey areas. They highlight soil limitations that affect various land uses and provide information about the properties of the soils in the survey areas. Soil surveys are designed for many different users, including farmers, ranchers, foresters, agronomists, urban planners, community officials, engineers, developers, builders, and home buyers. Also, conservationists, teachers, students, and specialists in recreation, waste disposal, and pollution control can use the surveys to help them understand, protect, or enhance the environment.

Various land use regulations of Federal, State, and local governments may impose special restrictions on land use or land treatment. Soil surveys identify soil properties that are used in making various land use or land treatment decisions. The information is intended to help the land users identify and reduce the effects of soil limitations on various land uses. The landowner or user is responsible for identifying and complying with existing laws and regulations.

Although soil survey information can be used for general farm, local, and wider area planning, onsite investigation is needed to supplement this information in some cases. Examples include soil quality assessments (<http://www.nrcs.usda.gov/wps/portal/nrcs/main/soils/health/>) and certain conservation and engineering applications. For more detailed information, contact your local USDA Service Center (<https://offices.sc.egov.usda.gov/locator/app?agency=nrcs>) or your NRCS State Soil Scientist ([http://www.nrcs.usda.gov/wps/portal/nrcs/detail/soils/contactus/?cid=nrcs142p2\\_053951](http://www.nrcs.usda.gov/wps/portal/nrcs/detail/soils/contactus/?cid=nrcs142p2_053951)).

Great differences in soil properties can occur within short distances. Some soils are seasonally wet or subject to flooding. Some are too unstable to be used as a foundation for buildings or roads. Clayey or wet soils are poorly suited to use as septic tank absorption fields. A high water table makes a soil poorly suited to basements or underground installations.

The National Cooperative Soil Survey is a joint effort of the United States Department of Agriculture and other Federal agencies, State agencies including the Agricultural Experiment Stations, and local agencies. The Natural Resources Conservation Service (NRCS) has leadership for the Federal part of the National Cooperative Soil Survey.

Information about soils is updated periodically. Updated information is available through the NRCS Web Soil Survey, the site for official soil survey information.

The U.S. Department of Agriculture (USDA) prohibits discrimination in all its programs and activities on the basis of race, color, national origin, age, disability, and where applicable, sex, marital status, familial status, parental status, religion, sexual orientation, genetic information, political beliefs, reprisal, or because all or a part of an individual's income is derived from any public assistance program. (Not all prohibited bases apply to all programs.) Persons with disabilities who require

alternative means for communication of program information (Braille, large print, audiotape, etc.) should contact USDA's TARGET Center at (202) 720-2600 (voice and TDD). To file a complaint of discrimination, write to USDA, Director, Office of Civil Rights, 1400 Independence Avenue, S.W., Washington, D.C. 20250-9410 or call (800) 795-3272 (voice) or (202) 720-6382 (TDD). USDA is an equal opportunity provider and employer.

# Contents

---

<b>Preface</b> .....	2
<b>How Soil Surveys Are Made</b> .....	5
<b>Soil Map</b> .....	8
Soil Map.....	9
Legend.....	10
Map Unit Legend.....	11
Map Unit Descriptions.....	11
King County Area, Washington.....	13
KpB—Kitsap silt loam, 2 to 8 percent slopes.....	13
KpD—Kitsap silt loam, 15 to 30 percent slopes.....	14
Pu—Puget silty clay loam.....	15
<b>Soil Information for All Uses</b> .....	17
Suitabilities and Limitations for Use.....	17
Water Management.....	17
Retention Systems, Unlined.....	17
Soil Properties and Qualities.....	23
Soil Qualities and Features.....	23
Hydrologic Soil Group.....	23
<b>References</b> .....	28



# How Soil Surveys Are Made

---

Soil surveys are made to provide information about the soils and miscellaneous areas in a specific area. They include a description of the soils and miscellaneous areas and their location on the landscape and tables that show soil properties and limitations affecting various uses. Soil scientists observed the steepness, length, and shape of the slopes; the general pattern of drainage; the kinds of crops and native plants; and the kinds of bedrock. They observed and described many soil profiles. A soil profile is the sequence of natural layers, or horizons, in a soil. The profile extends from the surface down into the unconsolidated material in which the soil formed or from the surface down to bedrock. The unconsolidated material is devoid of roots and other living organisms and has not been changed by other biological activity.

Currently, soils are mapped according to the boundaries of major land resource areas (MLRAs). MLRAs are geographically associated land resource units that share common characteristics related to physiography, geology, climate, water resources, soils, biological resources, and land uses (USDA, 2006). Soil survey areas typically consist of parts of one or more MLRA.

The soils and miscellaneous areas in a survey area occur in an orderly pattern that is related to the geology, landforms, relief, climate, and natural vegetation of the area. Each kind of soil and miscellaneous area is associated with a particular kind of landform or with a segment of the landform. By observing the soils and miscellaneous areas in the survey area and relating their position to specific segments of the landform, a soil scientist develops a concept, or model, of how they were formed. Thus, during mapping, this model enables the soil scientist to predict with a considerable degree of accuracy the kind of soil or miscellaneous area at a specific location on the landscape.

Commonly, individual soils on the landscape merge into one another as their characteristics gradually change. To construct an accurate soil map, however, soil scientists must determine the boundaries between the soils. They can observe only a limited number of soil profiles. Nevertheless, these observations, supplemented by an understanding of the soil-vegetation-landscape relationship, are sufficient to verify predictions of the kinds of soil in an area and to determine the boundaries.

Soil scientists recorded the characteristics of the soil profiles that they studied. They noted soil color, texture, size and shape of soil aggregates, kind and amount of rock fragments, distribution of plant roots, reaction, and other features that enable them to identify soils. After describing the soils in the survey area and determining their properties, the soil scientists assigned the soils to taxonomic classes (units). Taxonomic classes are concepts. Each taxonomic class has a set of soil characteristics with precisely defined limits. The classes are used as a basis for comparison to classify soils systematically. Soil taxonomy, the system of taxonomic classification used in the United States, is based mainly on the kind and character of soil properties and the arrangement of horizons within the profile. After the soil

## Custom Soil Resource Report

scientists classified and named the soils in the survey area, they compared the individual soils with similar soils in the same taxonomic class in other areas so that they could confirm data and assemble additional data based on experience and research.

The objective of soil mapping is not to delineate pure map unit components; the objective is to separate the landscape into landforms or landform segments that have similar use and management requirements. Each map unit is defined by a unique combination of soil components and/or miscellaneous areas in predictable proportions. Some components may be highly contrasting to the other components of the map unit. The presence of minor components in a map unit in no way diminishes the usefulness or accuracy of the data. The delineation of such landforms and landform segments on the map provides sufficient information for the development of resource plans. If intensive use of small areas is planned, onsite investigation is needed to define and locate the soils and miscellaneous areas.

Soil scientists make many field observations in the process of producing a soil map. The frequency of observation is dependent upon several factors, including scale of mapping, intensity of mapping, design of map units, complexity of the landscape, and experience of the soil scientist. Observations are made to test and refine the soil-landscape model and predictions and to verify the classification of the soils at specific locations. Once the soil-landscape model is refined, a significantly smaller number of measurements of individual soil properties are made and recorded. These measurements may include field measurements, such as those for color, depth to bedrock, and texture, and laboratory measurements, such as those for content of sand, silt, clay, salt, and other components. Properties of each soil typically vary from one point to another across the landscape.

Observations for map unit components are aggregated to develop ranges of characteristics for the components. The aggregated values are presented. Direct measurements do not exist for every property presented for every map unit component. Values for some properties are estimated from combinations of other properties.

While a soil survey is in progress, samples of some of the soils in the area generally are collected for laboratory analyses and for engineering tests. Soil scientists interpret the data from these analyses and tests as well as the field-observed characteristics and the soil properties to determine the expected behavior of the soils under different uses. Interpretations for all of the soils are field tested through observation of the soils in different uses and under different levels of management. Some interpretations are modified to fit local conditions, and some new interpretations are developed to meet local needs. Data are assembled from other sources, such as research information, production records, and field experience of specialists. For example, data on crop yields under defined levels of management are assembled from farm records and from field or plot experiments on the same kinds of soil.

Predictions about soil behavior are based not only on soil properties but also on such variables as climate and biological activity. Soil conditions are predictable over long periods of time, but they are not predictable from year to year. For example, soil scientists can predict with a fairly high degree of accuracy that a given soil will have a high water table within certain depths in most years, but they cannot predict that a high water table will always be at a specific level in the soil on a specific date.

After soil scientists located and identified the significant natural bodies of soil in the survey area, they drew the boundaries of these bodies on aerial photographs and

## Custom Soil Resource Report

identified each as a specific map unit. Aerial photographs show trees, buildings, fields, roads, and rivers, all of which help in locating boundaries accurately.

# Soil Map

---

The soil map section includes the soil map for the defined area of interest, a list of soil map units on the map and extent of each map unit, and cartographic symbols displayed on the map. Also presented are various metadata about data used to produce the map, and a description of each soil map unit.

# Custom Soil Resource Report Soil Map



Map Scale: 1:1,320 if printed on A landscape (11" x 8.5") sheet.

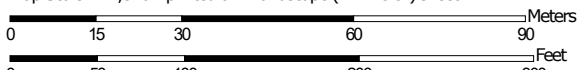

Map projection: Web Mercator Corner coordinates: WGS84 Edge tics: UTM Zone 10N WGS84

### MAP LEGEND

**Area of Interest (AOI)**

 Area of Interest (AOI)



















**Soils**







 Soil Map Unit Polygons

 Soil Map Unit Lines

 Soil Map Unit Points

**Special Point Features**





-  Blowout
-  Borrow Pit
-  Clay Spot
-  Closed Depression
-  Gravel Pit
-  Gravelly Spot
-  Landfill
-  Lava Flow
-  Marsh or swamp
-  Mine or Quarry
-  Miscellaneous Water
-  Perennial Water
-  Rock Outcrop
-  Saline Spot
-  Sandy Spot
-  Severely Eroded Spot
-  Sinkhole
-  Slide or Slip
-  Sodic Spot

-  Spoil Area
-  Stony Spot
-  Very Stony Spot
-  Wet Spot
-  Other
-  Special Line Features

**Water Features**

 Streams and Canals

**Transportation**

-  Rails
-  Interstate Highways
-  US Routes
-  Major Roads
-  Local Roads

**Background**

 Aerial Photography

### MAP INFORMATION

The soil surveys that comprise your AOI were mapped at 1:24,000.

Warning: Soil Map may not be valid at this scale.

Enlargement of maps beyond the scale of mapping can cause misunderstanding of the detail of mapping and accuracy of soil line placement. The maps do not show the small areas of contrasting soils that could have been shown at a more detailed scale.

Please rely on the bar scale on each map sheet for map measurements.

Source of Map: Natural Resources Conservation Service  
 Web Soil Survey URL:  
 Coordinate System: Web Mercator (EPSG:3857)

Maps from the Web Soil Survey are based on the Web Mercator projection, which preserves direction and shape but distorts distance and area. A projection that preserves area, such as the Albers equal-area conic projection, should be used if more accurate calculations of distance or area are required.

This product is generated from the USDA-NRCS certified data as of the version date(s) listed below.

Soil Survey Area: King County Area, Washington  
 Survey Area Data: Version 18, Sep 8, 2022

Soil map units are labeled (as space allows) for map scales 1:50,000 or larger.

Date(s) aerial images were photographed: Jul 6, 2020—Jul 20, 2020

The orthophoto or other base map on which the soil lines were compiled and digitized probably differs from the background imagery displayed on these maps. As a result, some minor shifting of map unit boundaries may be evident.



## Map Unit Legend

Map Unit Symbol	Map Unit Name	Acres in AOI	Percent of AOI
KpB	Kitsap silt loam, 2 to 8 percent slopes	4.2	62.4%
KpD	Kitsap silt loam, 15 to 30 percent slopes	0.2	2.4%
Pu	Puget silty clay loam	2.4	35.1%
<b>Totals for Area of Interest</b>		<b>6.8</b>	<b>100.0%</b>

## Map Unit Descriptions

The map units delineated on the detailed soil maps in a soil survey represent the soils or miscellaneous areas in the survey area. The map unit descriptions, along with the maps, can be used to determine the composition and properties of a unit.

A map unit delineation on a soil map represents an area dominated by one or more major kinds of soil or miscellaneous areas. A map unit is identified and named according to the taxonomic classification of the dominant soils. Within a taxonomic class there are precisely defined limits for the properties of the soils. On the landscape, however, the soils are natural phenomena, and they have the characteristic variability of all natural phenomena. Thus, the range of some observed properties may extend beyond the limits defined for a taxonomic class. Areas of soils of a single taxonomic class rarely, if ever, can be mapped without including areas of other taxonomic classes. Consequently, every map unit is made up of the soils or miscellaneous areas for which it is named and some minor components that belong to taxonomic classes other than those of the major soils.

Most minor soils have properties similar to those of the dominant soil or soils in the map unit, and thus they do not affect use and management. These are called noncontrasting, or similar, components. They may or may not be mentioned in a particular map unit description. Other minor components, however, have properties and behavioral characteristics divergent enough to affect use or to require different management. These are called contrasting, or dissimilar, components. They generally are in small areas and could not be mapped separately because of the scale used. Some small areas of strongly contrasting soils or miscellaneous areas are identified by a special symbol on the maps. If included in the database for a given area, the contrasting minor components are identified in the map unit descriptions along with some characteristics of each. A few areas of minor components may not have been observed, and consequently they are not mentioned in the descriptions, especially where the pattern was so complex that it was impractical to make enough observations to identify all the soils and miscellaneous areas on the landscape.

The presence of minor components in a map unit in no way diminishes the usefulness or accuracy of the data. The objective of mapping is not to delineate pure taxonomic classes but rather to separate the landscape into landforms or landform segments that have similar use and management requirements. The

## Custom Soil Resource Report

delineation of such segments on the map provides sufficient information for the development of resource plans. If intensive use of small areas is planned, however, onsite investigation is needed to define and locate the soils and miscellaneous areas.

An identifying symbol precedes the map unit name in the map unit descriptions. Each description includes general facts about the unit and gives important soil properties and qualities.

Soils that have profiles that are almost alike make up a *soil series*. Except for differences in texture of the surface layer, all the soils of a series have major horizons that are similar in composition, thickness, and arrangement.

Soils of one series can differ in texture of the surface layer, slope, stoniness, salinity, degree of erosion, and other characteristics that affect their use. On the basis of such differences, a soil series is divided into *soil phases*. Most of the areas shown on the detailed soil maps are phases of soil series. The name of a soil phase commonly indicates a feature that affects use or management. For example, Alpha silt loam, 0 to 2 percent slopes, is a phase of the Alpha series.

Some map units are made up of two or more major soils or miscellaneous areas. These map units are complexes, associations, or undifferentiated groups.

A *complex* consists of two or more soils or miscellaneous areas in such an intricate pattern or in such small areas that they cannot be shown separately on the maps. The pattern and proportion of the soils or miscellaneous areas are somewhat similar in all areas. Alpha-Beta complex, 0 to 6 percent slopes, is an example.

An *association* is made up of two or more geographically associated soils or miscellaneous areas that are shown as one unit on the maps. Because of present or anticipated uses of the map units in the survey area, it was not considered practical or necessary to map the soils or miscellaneous areas separately. The pattern and relative proportion of the soils or miscellaneous areas are somewhat similar. Alpha-Beta association, 0 to 2 percent slopes, is an example.

An *undifferentiated group* is made up of two or more soils or miscellaneous areas that could be mapped individually but are mapped as one unit because similar interpretations can be made for use and management. The pattern and proportion of the soils or miscellaneous areas in a mapped area are not uniform. An area can be made up of only one of the major soils or miscellaneous areas, or it can be made up of all of them. Alpha and Beta soils, 0 to 2 percent slopes, is an example.

Some surveys include *miscellaneous areas*. Such areas have little or no soil material and support little or no vegetation. Rock outcrop is an example.



## King County Area, Washington

### KpB—Kitsap silt loam, 2 to 8 percent slopes

#### Map Unit Setting

*National map unit symbol:* 1hmt9  
*Elevation:* 0 to 590 feet  
*Mean annual precipitation:* 37 inches  
*Mean annual air temperature:* 50 degrees F  
*Frost-free period:* 160 to 200 days  
*Farmland classification:* All areas are prime farmland

#### Map Unit Composition

*Kitsap and similar soils:* 85 percent  
*Minor components:* 15 percent  
*Estimates are based on observations, descriptions, and transects of the mapunit.*

#### Description of Kitsap

##### Setting

*Landform:* Terraces  
*Parent material:* Lacustrine deposits with a minor amount of volcanic ash

##### Typical profile

*H1 - 0 to 5 inches:* silt loam  
*H2 - 5 to 24 inches:* silt loam  
*H3 - 24 to 60 inches:* stratified silt to silty clay loam

##### Properties and qualities

*Slope:* 2 to 8 percent  
*Depth to restrictive feature:* More than 80 inches  
*Drainage class:* Moderately well drained  
*Capacity of the most limiting layer to transmit water (Ksat):* Moderately low to moderately high (0.06 to 0.20 in/hr)  
*Depth to water table:* About 18 to 36 inches  
*Frequency of flooding:* None  
*Frequency of ponding:* None  
*Available water supply, 0 to 60 inches:* High (about 11.4 inches)

##### Interpretive groups

*Land capability classification (irrigated):* None specified  
*Land capability classification (nonirrigated):* 3w  
*Hydrologic Soil Group:* C  
*Ecological site:* F002XA004WA - Puget Lowlands Forest  
*Forage suitability group:* Soils with Few Limitations (G002XN502WA)  
*Other vegetative classification:* Soils with Few Limitations (G002XN502WA)  
*Hydric soil rating:* No

#### Minor Components

##### Alderwood

*Percent of map unit:* 10 percent  
*Hydric soil rating:* No

##### Bellingham

*Percent of map unit:* 3 percent

## Custom Soil Resource Report

*Landform:* Depressions  
*Other vegetative classification:* Wet Soils (G002XN102WA)  
*Hydric soil rating:* Yes

### **Tukwila**

*Percent of map unit:* 1 percent  
*Landform:* Depressions  
*Other vegetative classification:* Wet Soils (G002XN102WA)  
*Hydric soil rating:* Yes

### **Seattle**

*Percent of map unit:* 1 percent  
*Landform:* Depressions  
*Other vegetative classification:* Wet Soils (G002XN102WA)  
*Hydric soil rating:* Yes

## **KpD—Kitsap silt loam, 15 to 30 percent slopes**

### **Map Unit Setting**

*National map unit symbol:* 1hmtc  
*Elevation:* 0 to 590 feet  
*Mean annual precipitation:* 37 inches  
*Mean annual air temperature:* 50 degrees F  
*Frost-free period:* 160 to 200 days  
*Farmland classification:* Farmland of statewide importance

### **Map Unit Composition**

*Kitsap and similar soils:* 97 percent  
*Minor components:* 3 percent  
*Estimates are based on observations, descriptions, and transects of the mapunit.*

### **Description of Kitsap**

#### **Setting**

*Landform:* Terraces  
*Parent material:* Lacustrine deposits with a minor amount of volcanic ash

#### **Typical profile**

*H1 - 0 to 5 inches:* silt loam  
*H2 - 5 to 40 inches:* silt loam  
*H3 - 40 to 60 inches:* stratified silt to silty clay loam

#### **Properties and qualities**

*Slope:* 15 to 30 percent  
*Depth to restrictive feature:* More than 80 inches  
*Drainage class:* Moderately well drained  
*Capacity of the most limiting layer to transmit water (Ksat):* Moderately low to moderately high (0.06 to 0.20 in/hr)  
*Depth to water table:* About 18 to 36 inches  
*Frequency of flooding:* None  
*Frequency of ponding:* None

## Custom Soil Resource Report

*Available water supply, 0 to 60 inches: High (about 11.4 inches)*

### **Interpretive groups**

*Land capability classification (irrigated): None specified*

*Land capability classification (nonirrigated): 4e*

*Hydrologic Soil Group: C*

*Ecological site: F002XA004WA - Puget Lowlands Forest*

*Forage suitability group: Sloping to Steep Soils (G002XN702WA)*

*Other vegetative classification: Sloping to Steep Soils (G002XN702WA)*

*Hydric soil rating: No*

### **Minor Components**

#### **Tukwila**

*Percent of map unit: 1 percent*

*Landform: Depressions*

*Other vegetative classification: Wet Soils (G002XN102WA)*

*Hydric soil rating: Yes*

#### **Bellingham**

*Percent of map unit: 1 percent*

*Landform: Depressions*

*Other vegetative classification: Wet Soils (G002XN102WA)*

*Hydric soil rating: Yes*

#### **Seattle**

*Percent of map unit: 1 percent*

*Landform: Depressions*

*Other vegetative classification: Wet Soils (G002XN102WA)*

*Hydric soil rating: Yes*

## **Pu—Puget silty clay loam**

### **Map Unit Setting**

*National map unit symbol: 1hmtt*

*Elevation: 10 to 650 feet*

*Mean annual precipitation: 35 to 55 inches*

*Mean annual air temperature: 48 to 50 degrees F*

*Frost-free period: 180 to 200 days*

*Farmland classification: Prime farmland if drained and either protected from flooding or not frequently flooded during the growing season*

### **Map Unit Composition**

*Puget and similar soils: 90 percent*

*Minor components: 10 percent*

*Estimates are based on observations, descriptions, and transects of the mapunit.*

### **Description of Puget**

#### **Setting**

*Landform: Flood plains*

## Custom Soil Resource Report

*Parent material:* Recent alluvium

### **Typical profile**

*H1 - 0 to 7 inches:* silty clay loam  
*H2 - 7 to 45 inches:* silty clay loam  
*H3 - 45 to 60 inches:* silty clay

### **Properties and qualities**

*Slope:* 0 to 1 percent  
*Depth to restrictive feature:* More than 80 inches  
*Drainage class:* Poorly drained  
*Capacity of the most limiting layer to transmit water (Ksat):* Moderately low to moderately high (0.06 to 0.20 in/hr)  
*Depth to water table:* About 0 to 12 inches  
*Frequency of flooding:* NoneFrequent  
*Frequency of ponding:* Frequent  
*Available water supply, 0 to 60 inches:* High (about 11.5 inches)

### **Interpretive groups**

*Land capability classification (irrigated):* None specified  
*Land capability classification (nonirrigated):* 5w  
*Hydrologic Soil Group:* C/D  
*Ecological site:* F002XA008WA - Puget Lowlands Riparian Forest  
*Forage suitability group:* Wet Soils (G002XN102WA)  
*Other vegetative classification:* Wet Soils (G002XN102WA)  
*Hydric soil rating:* Yes

### **Minor Components**

#### **Snohomish, undrained**

*Percent of map unit:* 5 percent  
*Landform:* Depressions  
*Other vegetative classification:* Wet Soils (G002XN102WA)  
*Hydric soil rating:* Yes

#### **Woodinville**

*Percent of map unit:* 5 percent  
*Landform:* Depressions  
*Other vegetative classification:* Wet Soils (G002XN102WA)  
*Hydric soil rating:* Yes

# **Soil Information for All Uses**

---

## **Suitabilities and Limitations for Use**

The Suitabilities and Limitations for Use section includes various soil interpretations displayed as thematic maps with a summary table for the soil map units in the selected area of interest. A single value or rating for each map unit is generated by aggregating the interpretive ratings of individual map unit components. This aggregation process is defined for each interpretation.

## **Water Management**

Water Management interpretations are tools for evaluating the potential of the soil in the application of various water management practices. Example interpretations include pond reservoir area, embankments, dikes, levees, and excavated ponds.

## **Retention Systems, Unlined**

Unlined retention systems are stormwater management practices that are placed 3 to 5 feet in the ground, depending on the application. These systems include retention basins and intermittent wetlands. They slow the movement of stormwater to surface waters and also filter a significant portion of pollutants from the stormwater. The fundamental function of these systems is to hold the runoff generated by an area, such as a parking lot, from the first 1 inch of rainfall during a 24-hour storm preceded by 48 hours of no measurable precipitation. Water should not be at the surface continuously, but a water table within the depth of the system is needed to allow the growth of hydrophytic vegetation. . Only that part of the soil between depths of 24 and 80 inches is evaluated.

The ratings are based on the soil properties that affect infiltration of the stormwater, construction and maintenance of the system, and public safety and health. Saturated hydraulic conductivity (Ksat), depth to a water table, ponding, depth to bedrock or a cemented pan, and flooding affect the transmission of rainwater. Stones and boulders, ice, and bedrock or a cemented pan interfere with installation. Subsidence interferes with installation and maintenance. Excessive slope may cause lateral seepage and surfacing of the water in downslope areas. Some slopes may become unstable and move upon addition of water.

## Custom Soil Resource Report

Soils underlain by loose sand and gravel or fractured bedrock at a depth of less than 4 feet below the bottom of the system may adversely affect water quality and public health. In these soils the unlined retention system may not adequately filter the stormwater, particularly if the adsorptive capacity of the soil below the system is low. As a result, the ground water may become contaminated. In areas underlain by limestone, solution channels and subsequent subsidence may damage adjacent infrastructure. . Also, areas underlain by limestone may be subject to ground-water contamination.

The ratings are both verbal and numerical. Rating class terms indicate the extent to which the soils are limited by all of the soil features that affect the specified system. "Not limited" indicates that the soil has features that are very favorable for the specified system. Good performance and very low maintenance can be expected. "Somewhat limited" indicates that the soil has features that are moderately favorable for the specified system. The limitations can be overcome or minimized by special planning, design, or installation. Fair performance and moderate maintenance can be expected. "Very limited" indicates that the soil has one or more features that are unfavorable for the specified system. The limitations generally cannot be overcome without major soil reclamation, special design, or expensive installation procedures. Poor performance and high maintenance can be expected.

Numerical ratings indicate the severity of individual limitations. The ratings are shown as decimal fractions ranging from 0.01 to 1.00. They indicate gradations between the point at which a soil feature has the greatest negative impact on the specified system (1.00) and the point at which the soil feature is not a limitation (0.00).

The accompanying Summary by Map Unit table in Web Soil Survey or the Aggregation Report in Soil Data Viewer lists the map unit components. These components are determined by the aggregation method chosen. An aggregated rating class is shown for each map unit. The components listed for each map unit are only those that have the same rating class as the one listed for the map unit. The percent composition of each component in a particular map unit is shown to help the user better understand the percentage of each map unit that has the rating indicated. Other components with different ratings may occur in each map unit.

The complete ratings list for all components, regardless of the map unit aggregated rating, can be viewed by generating the equivalent report from the Soil Reports tab in Web Soil Survey or from the Soil Data Mart site. Onsite investigation may be needed to validate these interpretations and to confirm the identity of the soil on a given site.

Custom Soil Resource Report  
Map—Retention Systems, Unlined



Soil Map may not be valid at this scale.

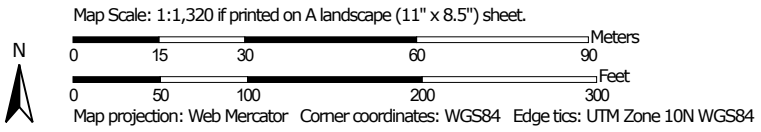



## MAP LEGEND

### Area of Interest (AOI)





 Area of Interest (AOI)

### Background





 Aerial Photography

### Soils





#### Soil Rating Polygons

-  Severely limited
-  Somewhat limited
-  Not limited
-  Not rated or not available

#### Soil Rating Lines

-  Severely limited
-  Somewhat limited
-  Not limited
-  Not rated or not available





#### Soil Rating Points

-  Severely limited
-  Somewhat limited
-  Not limited
-  Not rated or not available

### Water Features

 Streams and Canals

### Transportation

-  Rails
-  Interstate Highways
-  US Routes
-  Major Roads
-  Local Roads

## MAP INFORMATION

The soil surveys that comprise your AOI were mapped at 1:24,000.

Warning: Soil Map may not be valid at this scale.

Enlargement of maps beyond the scale of mapping can cause misunderstanding of the detail of mapping and accuracy of soil line placement. The maps do not show the small areas of contrasting soils that could have been shown at a more detailed scale.

Please rely on the bar scale on each map sheet for map measurements.

Source of Map: Natural Resources Conservation Service  
 Web Soil Survey URL:  
 Coordinate System: Web Mercator (EPSG:3857)

Maps from the Web Soil Survey are based on the Web Mercator projection, which preserves direction and shape but distorts distance and area. A projection that preserves area, such as the Albers equal-area conic projection, should be used if more accurate calculations of distance or area are required.

This product is generated from the USDA-NRCS certified data as of the version date(s) listed below.

Soil Survey Area: King County Area, Washington  
 Survey Area Data: Version 18, Sep 8, 2022

Soil map units are labeled (as space allows) for map scales 1:50,000 or larger.

Date(s) aerial images were photographed: Jul 6, 2020—Jul 20, 2020

The orthophoto or other base map on which the soil lines were compiled and digitized probably differs from the background imagery displayed on these maps. As a result, some minor shifting of map unit boundaries may be evident.



Custom Soil Resource Report

**Tables—Retention Systems, Unlined**

Map unit symbol	Map unit name	Rating	Component name (percent)	Rating reasons (numeric values)	Acres in AOI	Percent of AOI
KpB	Kitsap silt loam, 2 to 8 percent slopes	Somewhat limited	Kitsap (85%)	Vegetation establishment (0.32)	4.2	62.4%
				Wetness interferes with installation (0.22)		
				Water movement (0.14)		
				Slope (0.12)		
				Insufficient groundwater (0.01)		
KpD	Kitsap silt loam, 15 to 30 percent slopes	Severely limited	Kitsap (97%)	Slope (1.00)	0.2	2.4%
				Wetness interferes with installation (0.22)		
				Vegetation establishment (0.16)		
				Water movement (0.14)		
				Insufficient groundwater (0.01)		
Pu	Puget silty clay loam	Severely limited	Puget (90%)	Flooding (1.00)	2.4	35.1%
				Wetness interferes with installation (0.17)		
				Water movement (0.14)		
				Vegetation establishment (0.05)		
<b>Totals for Area of Interest</b>					<b>6.8</b>	<b>100.0%</b>

Rating	Acres in AOI	Percent of AOI
Somewhat limited	4.2	62.4%
Severely limited	2.6	37.6%
<b>Totals for Area of Interest</b>	<b>6.8</b>	<b>100.0%</b>

**Rating Options—Retention Systems, Unlined**

*Aggregation Method:* Dominant Condition

*Component Percent Cutoff:* None Specified

*Tie-break Rule:* Higher

## Soil Properties and Qualities

The Soil Properties and Qualities section includes various soil properties and qualities displayed as thematic maps with a summary table for the soil map units in the selected area of interest. A single value or rating for each map unit is generated by aggregating the interpretive ratings of individual map unit components. This aggregation process is defined for each property or quality.

## Soil Qualities and Features

Soil qualities are behavior and performance attributes that are not directly measured, but are inferred from observations of dynamic conditions and from soil properties. Example soil qualities include natural drainage, and frost action. Soil features are attributes that are not directly part of the soil. Example soil features include slope and depth to restrictive layer. These features can greatly impact the use and management of the soil.

## Hydrologic Soil Group

Hydrologic soil groups are based on estimates of runoff potential. Soils are assigned to one of four groups according to the rate of water infiltration when the soils are not protected by vegetation, are thoroughly wet, and receive precipitation from long-duration storms.

The soils in the United States are assigned to four groups (A, B, C, and D) and three dual classes (A/D, B/D, and C/D). The groups are defined as follows:

Group A. Soils having a high infiltration rate (low runoff potential) when thoroughly wet. These consist mainly of deep, well drained to excessively drained sands or gravelly sands. These soils have a high rate of water transmission.

Group B. Soils having a moderate infiltration rate when thoroughly wet. These consist chiefly of moderately deep or deep, moderately well drained or well drained soils that have moderately fine texture to moderately coarse texture. These soils have a moderate rate of water transmission.

Group C. Soils having a slow infiltration rate when thoroughly wet. These consist chiefly of soils having a layer that impedes the downward movement of water or soils of moderately fine texture or fine texture. These soils have a slow rate of water transmission.

Group D. Soils having a very slow infiltration rate (high runoff potential) when thoroughly wet. These consist chiefly of clays that have a high shrink-swell potential, soils that have a high water table, soils that have a claypan or clay layer at

## Custom Soil Resource Report

or near the surface, and soils that are shallow over nearly impervious material. These soils have a very slow rate of water transmission.

If a soil is assigned to a dual hydrologic group (A/D, B/D, or C/D), the first letter is for drained areas and the second is for undrained areas. Only the soils that in their natural condition are in group D are assigned to dual classes.

# Custom Soil Resource Report Map—Hydrologic Soil Group



Map Scale: 1:1,320 if printed on A landscape (11" x 8.5") sheet.

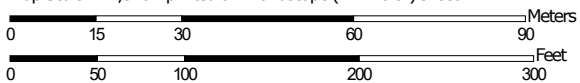









Map projection: Web Mercator Corner coordinates: WGS84 Edge tics: UTM Zone 10N WGS84

### MAP LEGEND









**Area of Interest (AOI)**  
 Area of Interest (AOI)

**Soils**





**Soil Rating Polygons**

-  A
-  A/D
-  B
-  B/D
-  C
-  C/D
-  D
-  Not rated or not available

**Soil Rating Lines**

-  A
-  A/D
-  B
-  B/D
-  C
-  C/D
-  D
-  Not rated or not available

**Soil Rating Points**

-  A
-  A/D
-  B
-  B/D

 C

 C/D

 D

 Not rated or not available

**Water Features**

 Streams and Canals

**Transportation**

 Rails

 Interstate Highways

 US Routes

 Major Roads

 Local Roads

**Background**

 Aerial Photography

### MAP INFORMATION

The soil surveys that comprise your AOI were mapped at 1:24,000.

Warning: Soil Map may not be valid at this scale.

Enlargement of maps beyond the scale of mapping can cause misunderstanding of the detail of mapping and accuracy of soil line placement. The maps do not show the small areas of contrasting soils that could have been shown at a more detailed scale.

Please rely on the bar scale on each map sheet for map measurements.

Source of Map: Natural Resources Conservation Service  
 Web Soil Survey URL:  
 Coordinate System: Web Mercator (EPSG:3857)

Maps from the Web Soil Survey are based on the Web Mercator projection, which preserves direction and shape but distorts distance and area. A projection that preserves area, such as the Albers equal-area conic projection, should be used if more accurate calculations of distance or area are required.

This product is generated from the USDA-NRCS certified data as of the version date(s) listed below.

Soil Survey Area: King County Area, Washington  
 Survey Area Data: Version 18, Sep 8, 2022

Soil map units are labeled (as space allows) for map scales 1:50,000 or larger.

Date(s) aerial images were photographed: Jul 6, 2020—Jul 20, 2020

The orthophoto or other base map on which the soil lines were compiled and digitized probably differs from the background imagery displayed on these maps. As a result, some minor shifting of map unit boundaries may be evident.

**Table—Hydrologic Soil Group**

Map unit symbol	Map unit name	Rating	Acres in AOI	Percent of AOI
KpB	Kitsap silt loam, 2 to 8 percent slopes	C	4.2	62.4%
KpD	Kitsap silt loam, 15 to 30 percent slopes	C	0.2	2.4%
Pu	Puget silty clay loam	C/D	2.4	35.1%
<b>Totals for Area of Interest</b>			<b>6.8</b>	<b>100.0%</b>

**Rating Options—Hydrologic Soil Group**

*Aggregation Method:* Dominant Condition

*Component Percent Cutoff:* None Specified

*Tie-break Rule:* Higher

# References

---

- American Association of State Highway and Transportation Officials (AASHTO). 2004. Standard specifications for transportation materials and methods of sampling and testing. 24th edition.
- American Society for Testing and Materials (ASTM). 2005. Standard classification of soils for engineering purposes. ASTM Standard D2487-00.
- Cowardin, L.M., V. Carter, F.C. Golet, and E.T. LaRoe. 1979. Classification of wetlands and deep-water habitats of the United States. U.S. Fish and Wildlife Service FWS/OBS-79/31.
- Federal Register. July 13, 1994. Changes in hydric soils of the United States.
- Federal Register. September 18, 2002. Hydric soils of the United States.
- Hurt, G.W., and L.M. Vasilas, editors. Version 6.0, 2006. Field indicators of hydric soils in the United States.
- National Research Council. 1995. Wetlands: Characteristics and boundaries.
- Soil Survey Division Staff. 1993. Soil survey manual. Soil Conservation Service. U.S. Department of Agriculture Handbook 18. [http://www.nrcs.usda.gov/wps/portal/nrcs/detail/national/soils/?cid=nrcs142p2\\_054262](http://www.nrcs.usda.gov/wps/portal/nrcs/detail/national/soils/?cid=nrcs142p2_054262)
- Soil Survey Staff. 1999. Soil taxonomy: A basic system of soil classification for making and interpreting soil surveys. 2nd edition. Natural Resources Conservation Service, U.S. Department of Agriculture Handbook 436. [http://www.nrcs.usda.gov/wps/portal/nrcs/detail/national/soils/?cid=nrcs142p2\\_053577](http://www.nrcs.usda.gov/wps/portal/nrcs/detail/national/soils/?cid=nrcs142p2_053577)
- Soil Survey Staff. 2010. Keys to soil taxonomy. 11th edition. U.S. Department of Agriculture, Natural Resources Conservation Service. [http://www.nrcs.usda.gov/wps/portal/nrcs/detail/national/soils/?cid=nrcs142p2\\_053580](http://www.nrcs.usda.gov/wps/portal/nrcs/detail/national/soils/?cid=nrcs142p2_053580)
- Tiner, R.W., Jr. 1985. Wetlands of Delaware. U.S. Fish and Wildlife Service and Delaware Department of Natural Resources and Environmental Control, Wetlands Section.
- United States Army Corps of Engineers, Environmental Laboratory. 1987. Corps of Engineers wetlands delineation manual. Waterways Experiment Station Technical Report Y-87-1.
- United States Department of Agriculture, Natural Resources Conservation Service. National forestry manual. [http://www.nrcs.usda.gov/wps/portal/nrcs/detail/soils/home/?cid=nrcs142p2\\_053374](http://www.nrcs.usda.gov/wps/portal/nrcs/detail/soils/home/?cid=nrcs142p2_053374)
- United States Department of Agriculture, Natural Resources Conservation Service. National range and pasture handbook. <http://www.nrcs.usda.gov/wps/portal/nrcs/detail/national/landuse/rangepasture/?cid=stelprdb1043084>



## Custom Soil Resource Report

United States Department of Agriculture, Natural Resources Conservation Service. National soil survey handbook, title 430-VI. [http://www.nrcs.usda.gov/wps/portal/nrcs/detail/soils/scientists/?cid=nrcs142p2\\_054242](http://www.nrcs.usda.gov/wps/portal/nrcs/detail/soils/scientists/?cid=nrcs142p2_054242)

United States Department of Agriculture, Natural Resources Conservation Service. 2006. Land resource regions and major land resource areas of the United States, the Caribbean, and the Pacific Basin. U.S. Department of Agriculture Handbook 296. [http://www.nrcs.usda.gov/wps/portal/nrcs/detail/national/soils/?cid=nrcs142p2\\_053624](http://www.nrcs.usda.gov/wps/portal/nrcs/detail/national/soils/?cid=nrcs142p2_053624)

United States Department of Agriculture, Soil Conservation Service. 1961. Land capability classification. U.S. Department of Agriculture Handbook 210. [http://www.nrcs.usda.gov/Internet/FSE\\_DOCUMENTS/nrcs142p2\\_052290.pdf](http://www.nrcs.usda.gov/Internet/FSE_DOCUMENTS/nrcs142p2_052290.pdf)

Appendix B:  
On – Site Detention Worksheet



**Table 1**

ON-SITE DETENTION DESIGN FOR PROJECTS BETWEEN 500 SF AND 9,500 SF NEW PLUS REPLACED IMPERVIOUS SURFACE AREA

New and Replaced Impervious Surface Area (sf)	Detention Pipe Diameter (in)	Detention Pipe Length (ft)		Lowest Orifice Diameter (in) <sup>(3)</sup>		Distance from Outlet Invert to Second Orifice (ft)		Second Orifice Diameter (in)	
		B soils	C soils	B soils	C soils	B soils	C soils	B soils	C soils
500 to 1,000 sf	36"	30	22	0.5	0.5	2.2	2.0	0.5	0.8
	48"	18	11	0.5	0.5	3.3	3.2	0.9	0.8
	60"	11	7	0.5	0.5	4.2	3.4	0.5	0.6
1,001 to 2,000 sf	36"	66	43	0.5	0.5	2.2	2.3	0.9	1.4
	48"	34	23	0.5	0.5	3.2	3.3	0.9	1.2
	60"	22	14	0.5	0.5	4.3	3.6	0.9	0.9
2,001 to 3,000 sf	36"	90	66	0.5	0.5	2.2	2.4	0.9	1.9
	48"	48	36	0.5	0.5	3.1	2.8	0.9	1.5
	60"	30	20	0.5	0.5	4.2	3.7	0.9	1.1
3,001 to 4,000 sf	36"	120	78	0.5	0.5	2.4	2.2	1.4	1.6
	48"	62	42	0.5	0.5	2.8	2.9	0.8	1.3
	60"	42	26	0.5	0.5	3.8	3.9	0.9	1.3
4,001 to 5,000 sf	36"	134	91	0.5	0.5	2.8	2.2	1.7	1.5
	48"	73	49	0.5	0.5	3.6	2.9	1.6	1.5
	60"	46	31	0.5	0.5	4.6	3.5	1.6	1.3
5,001 to 6,000 sf	36"	162	109	0.5	0.5	2.7	2.2	1.8	1.6
	48"	90	59	0.5	0.5	3.5	2.9	1.7	1.5
	60"	54	37	0.5	0.5	4.6	3.6	1.6	1.4
6,001 to 7,000 sf	36"	192	128	0.5	0.5	2.7	2.2	1.9	1.8
	48"	102	68	0.5	0.5	3.7	2.9	1.9	1.6
	60"	64	43	0.5	0.5	4.6	3.6	1.8	1.5
7,001 to 8,000 sf	36"	216	146	0.5	0.5	2.8	2.2	2.0	1.9
	48"	119	79	0.5	0.5	3.8	2.9	2.2	1.7
	60"	73	49	0.5	0.5	4.5	3.6	2.0	1.6
8,001 to 8,500 sf <sup>(1)</sup>	36"	228	155	0.5	0.5	2.8	2.2	2.1	1.9
	48"	124	84	0.5	0.5	3.7	2.9	1.9	1.8
	60"	77	53	0.5	0.5	4.6	3.6	2.0	1.6
8,501 to 9,000 sf	36"	NA <sup>(1)</sup>	164	0.5	0.5	NA <sup>(1)</sup>	2.2	NA <sup>(1)</sup>	1.9
	48"	NA <sup>(1)</sup>	89	0.5	0.5	NA <sup>(1)</sup>	2.9	NA <sup>(1)</sup>	1.9
	60"	NA <sup>(1)</sup>	55	0.5	0.5	NA <sup>(1)</sup>	3.6	NA <sup>(1)</sup>	1.7
9,001 to 9,500 sf <sup>(2)</sup>	36"	NA <sup>(1)</sup>	174	0.5	0.5	NA <sup>(1)</sup>	2.2	NA <sup>(1)</sup>	2.1
	48"	NA <sup>(1)</sup>	94	0.5	0.5	NA <sup>(1)</sup>	2.9	NA <sup>(1)</sup>	2.0
	60"	NA <sup>(1)</sup>	58	0.5	0.5	NA <sup>(1)</sup>	3.7	NA <sup>(1)</sup>	1.7

**Notes:**

▪ Minimum Requirement #7 (Flow Control) is required when the 100-year flow frequency causes a 0.15 cubic feet per second increase (when modeled in WWHM with a 15-minute timestep). Breakpoints shown in this table are based on a flat slope (0-5%). The 100-year flow frequency will need to be evaluated on a site-specific basis for projects on moderate (5-15%) or steep (> 15%) slopes.

- Soil type to be determined by geotechnical analysis or soil map.
- Sizing includes a Volume Correction Factor of 120%.
- Upper bound contributing area used for sizing.

<sup>(1)</sup> On Type B soils, new plus replaced impervious surface areas exceeding 8,500 sf trigger Minimum Requirement #7 (Flow Control)

<sup>(2)</sup> On Type C soils, new plus replaced impervious surface areas exceeding 9,500 sf trigger Minimum Requirement #7 (Flow Control)

<sup>(3)</sup> Minimum orifice diameter = 0.5 inches

in = inch

ft = feet

sf = square feet

**Basis of Sizing Assumptions:**

Sized per MR#5 in the Stormwater Management Manual for Puget Sound Basin (1992 Ecology Manual)  
 SBUH, Type 1A, 24-hour hydrograph  
 2-year, 24-hour storm = 2 in; 10-year, 24-hour storm = 3 in; 100-year, 24-hour storm = 4 in  
 Predeveloped = second growth forest (CN = 72 for Type B soils, CN = 81 for Type C soils)  
 Developed = impervious (CN = 98)  
 0.5 foot of sediment storage in detention pipe  
 Overland slope = 5%

**ATTACHMENT 1  
CITY OF MERCER ISLAND  
ON-SITE DETENTION SYSTEM WORKSHEET  
(FOR NEW PLUS REPLACED IMPERVIOUS  
AREA OF 9,500 SF OR LESS)**

OWNER: Blaze Pattinson ADDRESS: 8019 SE 20th STREET PREPARED BY: ZAC GARRARD  
 PERMIT #: TBD MERCER ISLAND, WA 98040 PHONE: 503-416-6850  
 CONTRIBUTING DATE: 9-20-2023  
 NEW PLUS REPLACED IMPERVIOUS DETENTION PIPE DIA (INCH): 60" DETENTION PIPE LENGTH (FT): 55' ORIFICE #1 DIA 0.5" INCH, ELEV 21.50'  
 SURFACE AREA (SF): 8,865 PIPE MATERIAL: HDPE SOIL TYPE: C/D - PUGET SILTY CLAY/LOAM ORIFICE #2 DIA 1.7" INCH, ELEV 27.10'

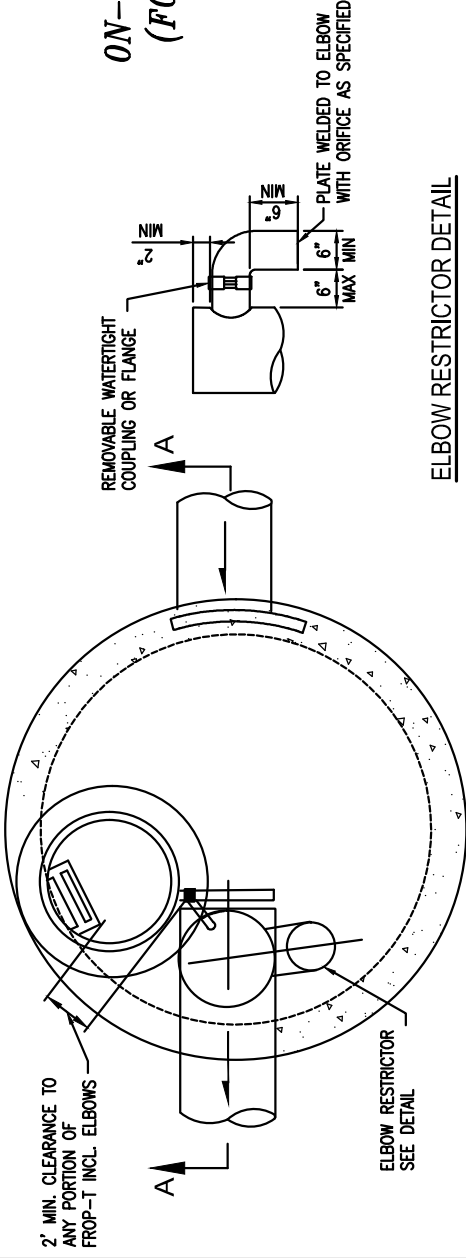

**ELBOW RESTRICTOR DETAIL**

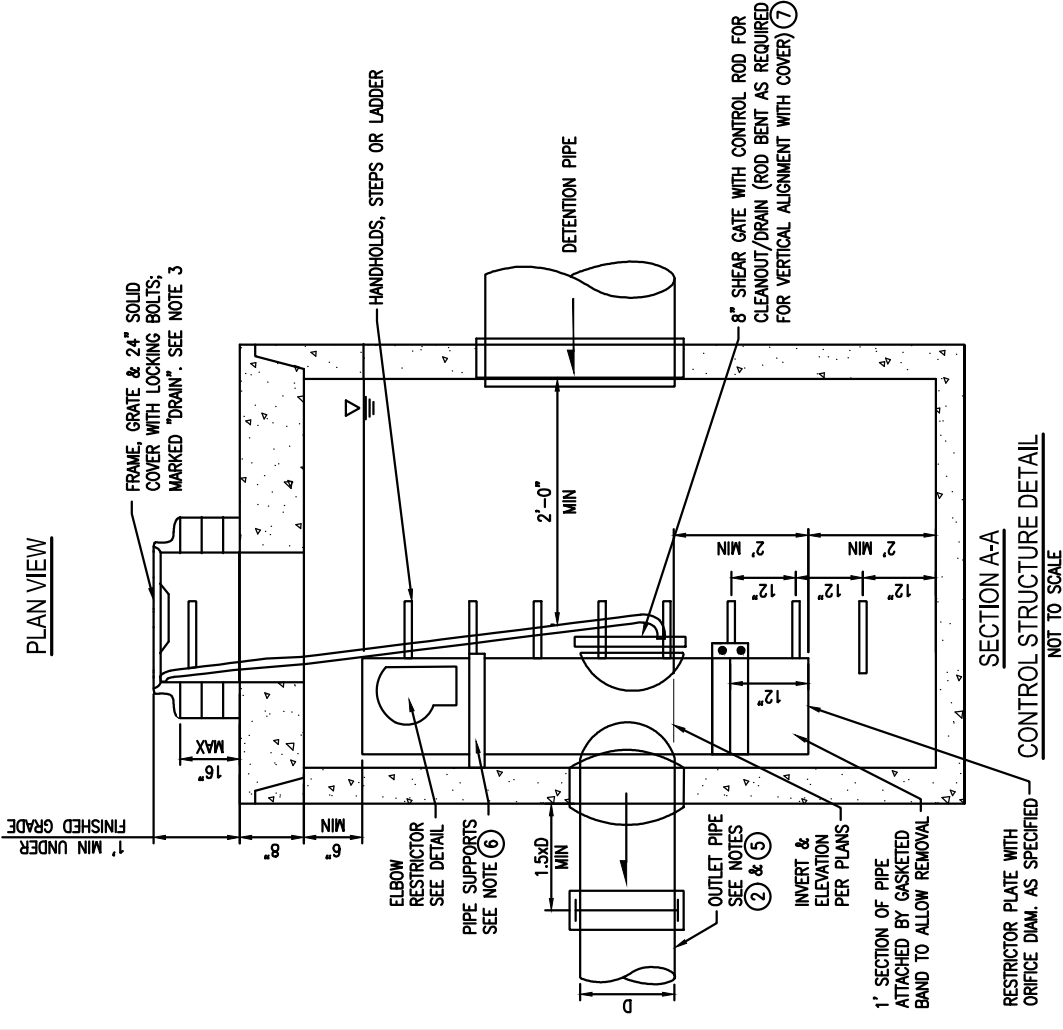

**SECTION A-A  
CONTROL STRUCTURE DETAIL  
NOT TO SCALE**

**ON-SITE DETENTION SYSTEM  
NOT TO SCALE (ENGINEER TO FILL IN BLANKS)**

**CONTROL STRUCTURE NOTES:**

- ① USE A MINIMUM OF A 54 IN. DIAM. TYPE 2 CATCH BASIN. THE ACTUAL SIZE IS DEPENDENT ON CONNECTING PIPE MATERIAL AND DIAMETER.
- ② OUTLET PIPE: MIN. 6 INCH.
- ③ METAL PARTS: CORROSION RESISTANT. NON-GALVANIZED PARTS PREFERRED. GALVANIZED PIPE PARTS TO HAVE ASPHALT TREATMENT 1.
- ④ FRAME AND LADDER OR STEPS OFFSET SO:
  - A. CLEANOUT GATE IS VISIBLE FROM TOP;
  - B. CLIMB-DOWN SPACE IS CLEAR OF RISER AND CLEANOUT GATE;
  - C. FRAME IS CLEAR OF CURB.
- ⑤ IF METAL OUTLET PIPE CONNECTS TO CEMENT CONCRETE PIPE, OUTLET PIPE TO HAVE SMOOTH O.D. EQUAL TO CONCRETE PIPE I.D. LESS 1/4 IN.

**ON-SITE DETENTION SYSTEM NOTES:**

1. CALL DEVELOPMENT SERVICES (206-275-7605) 24 HOURS IN ADVANCE FOR A DETENTION SYSTEM INSPECTION BEFORE BACKFILLING AND FOR FINAL INSPECTIONS.
2. RESPONSIBILITY FOR OPERATION AND MAINTENANCE OF DRAINAGE SYSTEMS ON PRIVATE PROPERTY IS RESPONSIBILITY OF THE PROPERTY OWNER. MATERIAL ACCUMULATED IN THE STORAGE PIPE MUST BE REMOVED FROM CATCH BASINS TO ALLOW PROPER OPERATION. THE OUTLET CONTROL ORIFICE MUST BE KEPT OPEN AT ALL TIMES.
3. PIPE MATERIAL, JOINT, AND PROTECTIVE TREATMENT SHALL BE IN ACCORDANCE WITH SECTION 7.04 AND 9.05 OF THE WSDOT STANDARD SPECIFICATION FOR ROAD, BRIDGE, AND MUNICIPAL CONSTRUCTION, LATEST VERSION. SUCH MATERIALS INCLUDE THE FOLLOWING: LINED CORRUGATED POLYETHYLENE PIPE (LCPE), ALUMINIZED TYPE 2 CORRUGATED STEEL PIPE AND PIPE ARCH (MEETS AASHTO DESIGNATIONS M274 AND M36), CORRUGATED OR SPIRAL RIB ALUMINUM PIPE, OR REINFORCED CONCRETE PIPE. CORRUGATED STEEL PIPE IS NOT ALLOWED.
4. FOOTING DRAINS SHALL NOT BE CONNECTED TO THE DETENTION SYSTEM.

Appendix C:  
Construction Stormwater Pollution  
Prevention Plan (CSWPPP)



# Pattison Family House Construction Stormwater Pollution Prevention Plan (CSWPPP)

*Prepared for*

**Blaze Pope**

8019 SE 20th Street  
Mercer Island, WA 98040

*Prepared by*

**Parametrix**

1019 39th Avenue SE, Suite 100  
Puyallup, WA 98374  
T. 253.604.6600 F. 1.855.542.6353  
[www.parametrix.com](http://www.parametrix.com)



# CITATION

Parametrix, 2023. Pattison Family House Construction Stormwater Pollution Prevention Plan (CSWPPP). Prepared by Parametrix, Puyallup, Washington. September 2023.

# TABLE OF CONTENTS

<b>1. PROJECT OVERVIEW</b>	<b>1</b>
<b>2. EXISTING SITE CONDITIONS</b>	<b>2</b>
2.1 Existing Topography & Vegetation	2
2.2 Existing Site Hydrology	2
2.3 Adjacent Areas	2
<b>3. CRITICAL AREAS</b>	<b>2</b>
<b>4. EROSION PROBLEM AREAS</b>	<b>2</b>
<b>5. CONSTRUCTION STORMWATER POLLUTION PREVENTION ELEMENTS</b>	<b>3</b>
5.1 Objective of the Stormwater Pollution Prevention Plan	3
5.2 Summary of Elements	3
5.3 Element #1: Preserve Vegetation/Mark Clearing Limits	3
5.4 Element #2: Establish Construction Access	4
5.5 Element #3: Control Flow Rates	4
5.6 Element #4: Install Sediment Controls	5
5.7 Element #5: Stabilize Soils	5
5.8 Element #6: Protect Slopes	6
5.9 Element #7: Protect Drain Inlets	6
5.10 Element #8: Stabilize Channels and Outlets	7
5.11 Element #9: Control Pollutants	7
5.12 Element #10: Control Dewatering	8
5.13 Element #11: Maintain BMPs	8
5.14 Element #12: Manage the Project	8
5.14.1 Phasing of Construction	8
5.14.2 Seasonal Work Limitations	9
5.14.3 Inspection and Monitoring	9
5.14.4 Maintenance of the SWPPP	9
5.15 Element #13: Protect Low-Impact Development (LID) BMPs	9
<b>6. ESTIMATED CONSTRUCTION SCHEDULE</b>	<b>10</b>
<b>7. REPORTING AND RECORD KEEPING</b>	<b>10</b>
7.1 Record Keeping	10



## TABLE OF CONTENTS (CONTINUED)

7.1.1 Site Logbook .....	10
7.1.2 Records Retention.....	10
7.1.3 Updating the SWPPP .....	11
7.2 Reporting.....	11
7.2.1 Reporting Requirements: .....	12
<b>8. SITE PLAN .....</b>	<b>13</b>
<b>LIST OF FIGURES</b>	
Figure 1 Project Vicinity Map .....	1
<b>LIST OF TABLES</b>	
Table 1 Preliminary Construction Schedule .....	10
<b>APPENDICES</b>	
A Appendix A: Erosion & Sediment Control BMPs	

## ACRONYMS AND ABBREVIATIONS

BMPs.....	best management practices
CESCL .....	Certified Erosion and Sediment Control Lead
CSWGP .....	Construction Stormwater General Permit
CSWPPP .....	Construction Stormwater Pollution Prevention Plan
DOE .....	Washington State Department of Ecology
LID .....	low-impact development
SPCC.....	Spill Prevention, Control, and Countermeasures
SWMMWW.....	2019 Stormwater Management Manual for Western Washington
TESC .....	Temporary Erosion and Sediment Control
TMDL .....	total maximum daily load



## 1. PROJECT OVERVIEW

The project proposes to remodel and reconstruct an existing single-family residence with a new primary structure, new garage, and extension to an existing garage in Mercer Island within a quarter mile from Lake Washington and half-mile from downtown Mercer Island. Specifically, it is located on a corner lot off the intersection of SE 80th Avenue and SE 20th Street addressed as 8019 SE 20th St, Mercer Island, WA 98040, Parcel No. 544930-0065.



**Figure 1 Project Vicinity Map**

The new construction will include 5,000 square feet of residential space, 1,650 square feet of driveway surfaces, and 1,935 square feet of patio space. As part of the construction the City's stormwater network will extend a new main down SE 20<sup>th</sup> Street nearly 100 linear feet (LF). All runoff generated from the rooftop of the new structure will be collected and conveyed via roof drains into an on-site detention system before conveying into the new storm main before discharging into Lake Washington.

Construction activities of the proposed project will include:

- Clearing and demolishing the existing residential structure
- Excavating and pouring a foundation and stem walls for new the structure
- Framing the new structure and garage extension
- Constructing retaining walls
- Resurfacing the driveway

**Total disturbed acreage:** 0.25 - acres

## 2. EXISTING SITE CONDITIONS

### 2.1 Existing Topography & Vegetation

The existing site is a single-family residence including a single-story structure with basement, two accessory garages, and patio space. The 0.43-acre lot is approximately 45% impervious surfaces with asphalt and rooftops hard surfaces with various landscaping plantings and trees aligning the perimeter of the property. An arborist report was prepared identifying the various trees on site, their dripline radii, and protection plan specifications.

The site is built within an existing hillside with foundation walls supporting the slope in some areas while additional rock walls retain in others. Slopes range from 5% up to 50%.

### 2.2 Existing Site Hydrology

Gutters align the rooftops of the existing structures, but it is not known where the downspout connect into whether it be on-site stormwater facilities or direct outfalls into the right-of-way. Any runoff collected in the landscape is presumed to infiltrate into the existing subgrade or sheet flow off-site.

### 2.3 Adjacent Areas

Nearby land use includes single-family residences and accesses to boat docks along Lake Washington.

## 3. CRITICAL AREAS

There are no identified critical areas within 100 feet of the construction site area. There are no critical areas within ¼ mile downstream of the project site.

## 4. EROSION PROBLEM AREAS

There are no specific areas identified as erosion prone or higher susceptibility. The primary anticipated erosion is sediment laden runoff as uncovered areas of the site encounter rainfall. Precautions and observations of exposed surface will be critical to minimize erosion and prevent/reduce stormwater pollution. Depending on the depth of excavation needed to prepare the structure's foundation, retaining the excavated footprint should monitored for stability and any erosion tracking off-site. Dewatering may occur to prepare the foundation for the structure.

## 5. CONSTRUCTION STORMWATER POLLUTION PREVENTION ELEMENTS

### 5.1 Objective of the Stormwater Pollution Prevention Plan

The purpose of a Construction Stormwater Pollution Prevention Plan (SWPPP) is to describe the potential for erosion, sediment, and pollution problems on a construction project. The SWPPP also explains and illustrates the measures to be taken on the construction site to control these problems.

This SWPPP is prepared according to the guidance of the 2019 Stormwater Management Manual for Western Washington (SWMWWW) – Washington State Department of Ecology (DOE). The SWMWWW describes thirteen necessary elements of construction stormwater pollution prevention. These thirteen elements include: preserving vegetation/mark clearing limits, establish construction access, control flow rates, install sediment controls, stabilize soils, protect slopes, protect drain inlets, stabilize channels and outlets, control pollutants, control de-watering, maintain Best Management Practices (BMPs), manage the project, and protect low-impact development BMPs. These elements have been addressed as follows.

### 5.2 Summary of Elements

The BMPs listed in this report, or their equivalent, are required. Any revisions by the contractor to the BMPs listed in the SWPPP shall be approved by the Engineer. Therefore, if the contractor does not require a BMP or needs to modify a BMP, the contractor shall document the reasons and update the SWPPP to match what is being implemented in the field. A copy of the BMPs can be found in Appendix A.

### 5.3 Element #1: Preserve Vegetation/Mark Clearing Limits

The clearing limits shall be marked prior to any clearing to restrict clearing to the approved limits. A high visibility fence shall be installed to delineate the extents of construction activities in accordance with BMP 103. No clearing or grubbing will begin until the limits have been delineated. The Contractor shall use best judgement selecting of the type of fencing (high orange fencing, chain-link with placards, or high visible silt fence) to be utilized.

**Installation Schedule:** Spring 2024

**Inspection and Maintenance Plan:**

- If the fencing or clearing limits are observed to be damaged or visibility is reduced, it shall be repaired and/or replaced immediately and visibility restored.
- Fence or clearly mark areas around trees that are to be saved at least to the extents of the dripline.

**Responsible Staff:**

- CESCL

## 5.4 Element #2: Establish Construction Access

A stabilized construction access is required to reduce the amount of sediment transported onto paved roads outside the project site. The existing asphalt driveway of the residence will be maintained and utilized throughout the construction schedule.

If sediment is tracked off-site, public roads shall be cleaned thoroughly at the end of each day, or more frequently during wet weather. Sediment shall be removed from roads by shoveling or pickup sweeping and shall be transported to a controlled sediment disposal area. Street washing will be allowed only after sediment is removed. Should tracking of sediments off-site continue to occur, wheel washes may be needed in accordance with BMP C106.

**Installation Schedule:** Spring 2024

**Inspection and Maintenance Plan:**

- If sediment or quarry spalls are observed being tracked onto pavement, then alternative measures to keep the street free of sediment shall be used. This may include replacement/cleaning of existing quarry spalls, street sweeping, an increase in the dimensions of the entrance, or the installation of a wheel wash.
- If a wheel wash is installed, the wheel wash should start out the day with fresh water, and the wash water should be changed a minimum once per day. The Contractor shall determine the frequency of changing the wash water.
- Inspect stabilized areas regularly, especially after large storm events. Crushed rock, gravel base, etc. shall be added as required to maintain a stable driving surface and to stabilize areas that have eroded.

**Responsible Staff:**

- CESCL

## 5.5 Element #3: Control Flow Rates

Stormwater runoff shall be observed during storm events to ensure flow rates are not increased to cause erosion to off-site locations. There are no proposed detention/retention facilities associated with the project. Straw wattles (BMP C235) will be placed intermittently throughout the site to dissipate stormwater flows from concentrated flow into dispersed segmental flows.

**Installation Schedule:** Spring 2024

**Inspection and Maintenance Plan:**

- Inspect wattles regularly, especially after large storm events.

**Responsible Staff:**

- CESCL

## 5.6 Element #4: Install Sediment Controls

To minimize the discharge of pollutants offsite, erosion and sediment controls will be installed along site perimeter. Stormwater runoff from disturbed areas shall be routed through an appropriate sediment removal BMP per the Contractor's best judgement prior to runoff discharging off-site.

The following BMPs may be implemented where appropriate:

- BMP C220 – Storm Drain Inlet Protectors
- BMP C230 – Straw Bale Barrier
- BMP C231 – Brusher Barrier
- BMP C233 – Silt Fence
- BMP C235 – Straw Wattles
- BMP C240 – Sediment Trap
- BMP C 251 – Construction Stormwater Filtration

**Installation Schedule:** Spring 2024

**Inspection and Maintenance Plan:**

- Repair any damage immediately.
- Replace filter fabric that has deteriorated due to ultraviolet breakdown.

**Responsible Staff:**

- CESCL

## 5.7 Element #5: Stabilize Soils

All exposed and unworked soils shall be stabilized by application of effective BMPs, which protect the soil from the erosive forces of raindrop impact, flowing water, and from wind erosion. Site demolition schedule phasing shall be planned to reduce the amount of soil exposed during construction activity.

From October 1 through April 30, no soils shall remain exposed and un-worked for more than 2 days. From May 1 to September 30, no soils shall remain exposed and un-worked for more than 7 days. This condition applies to all soils on-site, whether at final grade or not. Soils to be stabilized at the end of shifts prior to holidays or weekends based on weather forecasts per Contractor's best judgement.

In areas where the soils will remain un-worked for more than 30 days or have reached final grade, plastic covering shall be used in accordance with BMP C123.

If the soil stockpile slope is 2H:1V or greater with at least 10 feet of vertical relief, nets, or blankets shall be used according to BMP C122. Dust control shall be used as needed to prevent wind transport of dust from disturbed soil surfaces and in accordance with BMP C140. Contractor to utilize available non-potable water from on-site sources or provide water tanker in order to spray down disturbed soils to minimize dust produced from construction activities.

**Installation Schedule:** Summer/Fall 2024

**Inspection and Maintenance Plan:**



- Reseed any seeded areas that fail to establish at least 80 percent cover. If reseeding is ineffective, use an alternative method such as sodding, mulching, or nets/blankets to stabilize soils.
- Respray areas as needed to keep dust to a minimum.

**Responsible Staff:**

- CESCL

## 5.8 Element #6: Protect Slopes

The contractor shall cut slopes in a manner to minimize erosion. Applicable practices include, but are not limited to, reducing continuous length of slope with terracing and diversions, reducing slope steepness, roughening slope surfaces, or shoring. Exposed slopes and soils can be covered by plastic sheeting. Divert off-site stormwater away from slopes and disturbed areas with interceptor dikes, pipes and/or swales. Off-site stormwater should be managed separately from stormwater generated on site.

**Installation Schedule:** Spring/Fall 2024

**Inspection and Maintenance Plan:**

- Areas that are surface roughened should be seeded as quickly as possible.
- Regular inspections should be made of the area. If rills appear, they should be re-roughened and re-seeded immediately.
- Terraces should be inspected regularly, at least once per year, and after large storm events.
- Torn sheets must be replaced and open seams repaired.
- Completely remove and replace the plastic if it begins to deteriorate due to ultraviolet radiation.
- Do not wash sediment into storm drains while cleaning.

**Responsible Staff:**

- CESCL

## 5.9 Element #7: Protect Drain Inlets

All storm drain inlets made operable during construction, as well as all existing structures within the project limits, shall be marked and protected so that stormwater runoff shall not enter the conveyance system without first being filtered or treated to remove sediment. Install catch basin sock filters or approved equal as shown on the TESC Plans and in accordance with BMP C220 or WSDOT standard I-40.20-00.

Contractor to prevent sediment and street wash water to enter storm drains without prior and adequate treatment.

**Installation Schedule:** Spring 2024

**Inspection and Maintenance Plan:**

- Inlets to be inspected weekly at a minimum and daily during storm events.

- Inlet protection devices shall be cleaned and removed and replaced when sediment has filled one-third of the available storage (unless a different standard is specified by the product manufacturer).
- Do not wash sediment into storm drains while cleaning.

**Responsible Staff:**

- CESCL

## 5.10 Element #8: Stabilize Channels and Outlets

There are no natural drainage channels or outlets within the project area that are anticipated to be prone to erosion or slope stability as a result of the project.

## 5.11 Element #9: Control Pollutants

Cement/concrete and associated curing waters from concrete production are the primary pollutants anticipated. All pollutants, including waste materials and demolition debris, that occur on-site during construction shall be handled and disposed of in a manner that does not cause contamination of stormwater.

Maintenance and repair of heavy equipment and vehicles involving oil changes, hydraulic system drain down, solvent, and de-greasing cleaning operations, fuel tank drain down and removal, and other activities which may result in discharge or spillage of pollutants to the ground or into stormwater runoff must be conducted using spill prevention measures, such as drip pans. Emergency repairs may be performed on-site using temporary plastic placed beneath, and if raining, over the vehicle.

If a wheel wash is utilized, wastewater shall be treated by an on-site treatment system that prevents discharge to surface waters, sanitary sewers, or wetland areas. It may be combined with wastewater from concrete washout areas if properly disposed of at an off-site location or treatment facility.

Source control BMPs that will apply to this project include:

- A Spill Prevention Control and Countermeasures Plan (prepared by Contractor)
- Construction Stormwater Filtration
- Concrete Washout Area
- Street Sweeping (as needed during construction by Contractor)

**Installation Schedule:** Summer/Fall 2024

**Inspection and Maintenance Plan:**

- Contaminated surfaces shall be cleaned immediately following any discharge or spill incident.
- Source control BMPs shall be utilized to prevent the likelihood of pollutants being introduced on-site.

**Responsible Staff:**

- CESCL

## 5.12 Element #10: Control Dewatering

If dewatering is required, dewatering water is to be treated similar to on-site stormwater runoff. It must be conveyed through appropriate BMPs prior to off-site discharge. On-site infiltration is the preferred option to manage dewatering waters. If no other options are available, the contractor shall coordinate with the City of Olympia to discharge dewatering water into the sanitary main following sedimentation/filtration facilities.

**Installation Schedule:** Summer/Fall 2024

**Inspection and Maintenance Plan:**

- Transport off site in a vehicle, such as a vacuum flush truck, for legal disposal.
- Observe the turbidity of the dewatering water to determine the appropriate BMP and discharge location.

**Responsible Staff:**

- CESCL

## 5.13 Element #11: Maintain BMPs

All temporary and permanent erosion and sediment control BMPs shall be maintained and repaired as needed to ensure continued performance of their intended function. All maintenance and repair shall be in accordance with BMPs.

Sediment control BMPs shall be inspected weekly or after a runoff-producing storm event during the dry season and daily during the wet season.

All temporary erosion and sediment control BMPs shall be removed within 30 days after final site stabilization is achieved, or after the temporary BMPs are no longer needed. Trapped sediment shall be removed or stabilized on-site. Disturbed soil areas resulting from removal of BMPs or vegetation shall be permanently stabilized.

**Installation Schedule:** Summer/Fall 2024

**Inspection and Maintenance Plan:**

- Inspect BMPs at regular intervals, especially following large storm events.

**Responsible Staff:**

- CESCL

## 5.14 Element #12: Manage the Project

### 5.14.1 Phasing of Construction

The project shall be phased where feasible in order to prevent, to the maximum extent practicable, the transport of sediment from the site during construction. The Contractor will install the aforementioned erosion and sediment control BMPs prior to any construction activities. BMPs will be installed and in place during and throughout the transition between phases as applicable. At the completion of the

demolition and site restoration, workers will do a final policing of the area, picking up any remaining debris, then remove the SWPPP control measures and security fencing.

### 5.14.2 Seasonal Work Limitations

From October 1 through April 30, clearing, grading, and other soil disturbing activities shall only be permitted if silt-laden runoff will be prevented from leaving the construction site.

The following activities are exempt from the seasonal clearing and grading limitations:

- Routine maintenance and necessary repair of erosion and sediment control BMPs;
- Routine maintenance of public facilities or existing utility structures that do not expose the soil or result in the removal of the vegetative cover to the soil; and
- Activities where there is 100 percent infiltration of surface water runoff within the site in approved and installed erosion and sediment control facilities.

### 5.14.3 Inspection and Monitoring

All BMPs shall be inspected, maintained, and repaired as needed to ensure continued performance of their intended function.

Sampling and analysis of the stormwater discharges from the construction site may be necessary to ensure compliance with standards.

Whenever inspection and/or monitoring reveals that the BMPs identified in the construction SWPPP are inadequate, due to the actual discharge of or potential to discharge a significant amount of any pollutant, the construction SWPPP shall be modified, as appropriate, in a timely manner.

Site inspections shall be conducted the identified CESCL. The CESCL must be on-site or on-call at all times during the duration of construction activities. The CESCL must examine stormwater visually for the presence of suspended sediment, turbidity, discoloration, and oil sheen, and it is upon the CESCL's evaluation of the effectiveness of BMPs to determine if it is necessary to install, maintain, or repair BMPs to improve quality of stormwater discharges.

The CESCL must inspect all areas disturbed by construction activities, all BMPs, and all stormwater discharge points at least once every calendar week and within 24 hours of any discharge from the site.

The CESCL may reduce this inspection frequency for temporary stabilized or inactive sites to once every calendar month through the duration of construction activities.

### 5.14.4 Maintenance of the SWPPP

The construction SWPPP shall be retained on-site or within reasonable access to the site. The construction SWPPP shall be modified by the Contractor and/or Engineer whenever there is a significant change in the design, construction, operation, or maintenance of any BMP.

## 5.15 Element #13: Protect Low-Impact Development (LID) BMPs

There are no LID elements within the project scope to protect.

## 6. ESTIMATED CONSTRUCTION SCHEDULE

**Table 1 Preliminary Construction Schedule**

<b>Construction Activity</b>	<b>Date of Completion</b>
Project Start	Spring 2024
Install Erosion and Sediment Control BMPs	Spring 2024
Notify Utility Providers for Shut-Off	Spring 2024
Demolition Begin	Spring 2024
Site Grading	Spring/Summer 2024
Structural	Summer 2024
Framing	Summer 2024
Interior	Fall/Winter 2024
Exterior	Winter/Spring 2025
Remove Erosion and Sediment Control BMPs	Spring 2025
Project End	Spring 2025

## 7. REPORTING AND RECORD KEEPING

### 7.1 Record Keeping

#### 7.1.1 Site Logbook

A site logbook will be maintained for all on-site construction activities and will include:

- A record of the implementation of the SWPPP and other permit requirements
- Site Inspections
- Sample Logs

#### 7.1.2 Records Retention

Records will be retained during the life of the project and for a minimum of 3 years following the termination of permit coverage in accordance with Special Condition S5.C of the CSWGP.

Permit documentation to be retained on-site:

- CSWGP
- Permit Coverage Letter
- SWPPP
- Site Logbook

Permit documentation will be provided within 14 days of receipt of a written request from Ecology. A copy of the SWPPP or access to the SWPPP will be provided to the public when requested in writing accordance with Special Condition S5.G.2.b of the CSWGP.

### 7.1.3 Updating the SWPPP

The SWPPP will be modified if:

- Found ineffective in eliminating or significantly minimizing pollutants in stormwater discharges from the site.
- There is a change in design, construction, operation, or maintenance at the construction site that has, or could have, a significant effect on the discharge of pollutants to waters of the State.

The SWPPP will be modified within 7 days if inspections or investigations determine additional or modified BMPs are necessary for compliance. An updated timeline for BMP implementation will be prepared.

## 7.2 Reporting

The NPDES regulations require the permittee to maintain records and periodically report on monitoring activities. The regulations at § 122.41(l)(4)(i) require that monitoring results must be reported on a DMR. Data reported include both data required by the permit and any additional data the permittee has collected consistent with permit requirements. All facilities must submit reports (on discharges and sludge use or disposal) at least annually, as required by § 122.44(i)(2). POTWs with pretreatment programs must submit a pretreatment report at least annually as required by § 403.12(i). However, the NPDES regulation states that monitoring frequency and reporting should be dependent on the nature and effect of the discharge or sludge use or disposal. Thus, the permit writer can require reporting more frequent than annually.

The permittee is required by § 122.41(j) to include in the permit the requirement to retain records for at least three years, subject to extension by the State Director. Monitoring records must include the following:

- Date, place, time of sampling
- Name of sampler
- Date of analysis
- Name of analyst
- Analytical methods used
- Analytical results

According to § 122.41(j), monitoring records must be representative of the discharge. Monitoring records, which must be retained, include continuous strip chart recordings, calibration data, copies of all reports for the permit, and copies of all data used to compile reports and applications. Sewage sludge regulations under §§ 503.17, 503.27, and 503.47 establish recordkeeping requirements that vary depending on the use and disposal method for the sewage sludge. The same recordkeeping requirements should be applied to other sludge monitoring parameters not regulated by the Part 503 rule.

## 7.2.1 Reporting Requirements:

- Planned changes. You must give notice to Ecology as soon as possible of any planned physical alterations or additions to the permitted facility. Notice is required only when:
  - The alteration or addition to a permitted facility may meet one of the criteria for determining whether a facility is a new source; or
  - The alteration or addition could significantly change the nature or increase the quantity of pollutants discharged. This notification applies to pollutants which are subject neither to effluent limitations in the permit, nor to notification requirements.
- Anticipated noncompliance. You must give advance notice to Ecology of any planned changes in the permitted facility or activity which may result in noncompliance with permit requirements.
- Transfers. This permit is not transferable to any person except after notice to Ecology. Where a facility wants to change the name of the permittee, the original permittee (the first owner or operators) must submit a Notice of Termination. The new owner or operator must submit a Notice of Intent
- Monitoring reports. Monitoring results must be reported at the intervals specified elsewhere in this permit.
  - Monitoring results must be reported on a Discharge Monitoring Report (DMR) or forms provided or specified by Ecology for reporting results of monitoring of sludge use or disposal practices.
  - If you monitor any pollutant more frequently than required by the permit using test procedures as specified in the permit, the results of this monitoring must be included in the calculation and reporting of the data submitted in the DMR or sludge reporting form specified by Ecology.
- Compliance schedules. Reports of compliance or noncompliance with, or any progress reports on, interim and final requirements contained in any compliance schedule of this permit must be submitted no later than 14 days following each schedule date.
- Twenty-four-hour reporting. In addition to reports required elsewhere in this permit:
  - You must report any noncompliance which may endanger health or the environment directly to the Ecology Regional Office. Any information must be provided orally within 24 hours from the time you become aware of the circumstances. A written submission must also be provided within five days of the time you become aware of the circumstances. The written submission must contain a description of the noncompliance and its cause; the period of noncompliance, including exact dates and times, and if the noncompliance has not been corrected, the anticipated time it is expected to continue; and steps taken or planned to reduce, eliminate, and prevent reoccurrence of the noncompliance.
  - The following shall be included as information which must be reported within 24 hours under this paragraph.
    - Any unanticipated bypass which exceeds any effluent limitation in the permit.
    - Any upset which exceeds any effluent limitation in the permit
    - Violation of a maximum daily discharge limit for any numeric effluent limitation.
  - Ecology may waive the written report on a case-by-case basis for reports if the oral report has been received within 24 hours.
  - Other noncompliance. You must report all instances of noncompliance not reported, at the time monitoring reports are submitted. Where you become aware that you failed to submit any relevant facts in a permit application or submitted incorrect information in a

permit application or in any report to the Permitting Authority, you must promptly submit such facts for information.

## 8. SITE PLAN

Refer to the erosion and sediment control plans submitted for this project for site location, project boundary, and erosion control plan.



# Appendix A: Erosion & Sediment Control BMPs



## 4.1 Source Control BMPs

### BMP C101: Preserving Natural Vegetation

#### *Purpose*

The purpose of preserving natural vegetation is to reduce erosion wherever practicable. Limiting site disturbance is the single most effective method for reducing erosion. For example, conifers can hold up to about 50 percent of all rain that falls during a storm. Up to 20-30 percent of this rain may never reach the ground but is taken up by the tree or evaporates. Another benefit is that the rain held in the tree can be released slowly to the ground after the storm.

#### *Conditions of Use*

- Natural vegetation should be preserved on steep slopes, near perennial and intermittent watercourses or swales, and on building sites in wooded areas.
- As required by local governments.

#### *Design and Installation Specifications*

Natural vegetation can be preserved in natural clumps or as individual trees, shrubs and vines.

The preservation of individual plants is more difficult because heavy equipment is generally used to remove unwanted vegetation. The points to remember when attempting to save individual plants are:

- Is the plant worth saving? Consider the location, species, size, age, vigor, and the work involved. Local governments may also have ordinances to save natural vegetation and trees.
- Fence or clearly mark areas around trees that are to be saved. It is preferable to keep ground disturbance away from the trees at least as far out as the dripline.

Plants need protection from three kinds of injuries:

- *Construction Equipment* - This injury can be above or below the ground level. Damage results from scarring, cutting of roots, and compaction of the soil. Placing a fenced buffer zone around plants to be saved prior to construction can prevent construction equipment injuries.
- *Grade Changes* - Changing the natural ground level will alter grades, which affects the plant's ability to obtain the necessary air, water, and minerals. Minor fills usually do not cause problems although sensitivity between species does vary and should be checked. Trees can tolerate fill of 6 inches or less. For shrubs and other plants, the fill should be less.

When there are major changes in grade, it may become necessary to supply air to the roots of plants. This can be done by placing a layer of gravel and a tile system over the roots before the fill is made. A tile

system protects a tree from a raised grade. The tile system should be laid out on the original grade leading from a dry well around the tree trunk. The system should then be covered with small stones to allow air to circulate over the root area.

Lowering the natural ground level can seriously damage trees and shrubs. The highest percentage of the plant roots are in the upper 12 inches of the soil and cuts of only 2-3 inches can cause serious injury. To protect the roots it may be necessary to terrace the immediate area around the plants to be saved. If roots are exposed, construction of retaining walls may be needed to keep the soil in place. Plants can also be preserved by leaving them on an undisturbed, gently sloping mound. To increase the chances for survival, it is best to limit grade changes and other soil disturbances to areas outside the dripline of the plant.

- *Excavations* - Protect trees and other plants when excavating for drainfields, power, water, and sewer lines. Where possible, the trenches should be routed around trees and large shrubs. When this is not possible, it is best to tunnel under them. This can be done with hand tools or with power augers. If it is not possible to route the trench around plants to be saved, then the following should be observed:

Cut as few roots as possible. When you have to cut, cut clean. Paint cut root ends with a wood dressing like asphalt base paint.

Backfill the trench as soon as possible.

Tunnel beneath root systems as close to the center of the main trunk to preserve most of the important feeder roots.

Some problems that can be encountered with a few specific trees are:

- Maple, Dogwood, Red alder, Western hemlock, Western red cedar, and Douglas fir do not readily adjust to changes in environment and special care should be taken to protect these trees.
- The windthrow hazard of Pacific silver fir and madronna is high, while that of Western hemlock is moderate. The danger of windthrow increases where dense stands have been thinned. Other species (unless they are on shallow, wet soils less than 20 inches deep) have a low windthrow hazard.
- Cottonwoods, maples, and willows have water-seeking roots. These can cause trouble in sewer lines and infiltration fields. On the other hand, they thrive in high moisture conditions that other trees would not.
- Thinning operations in pure or mixed stands of Grand fir, Pacific silver fir, Noble fir, Sitka spruce, Western red cedar, Western hemlock,

Pacific dogwood, and Red alder can cause serious disease problems. Disease can become established through damaged limbs, trunks, roots, and freshly cut stumps. Diseased and weakened trees are also susceptible to insect attack.

***Maintenance  
Standards***

- Inspect flagged and/or fenced areas regularly to make sure flagging or fencing has not been removed or damaged. If the flagging or fencing has been damaged or visibility reduced, it shall be repaired or replaced immediately and visibility restored.
- If tree roots have been exposed or injured, “prune” cleanly with an appropriate pruning saw or loppers directly above the damaged roots and recover with native soils. Treatment of sap flowing trees (fir, hemlock, pine, soft maples) is not advised as sap forms a natural healing barrier.

## **BMP C103: High Visibility Plastic or Metal Fence**

***Purpose*** Fencing is intended to: (1) restrict clearing to approved limits; (2) prevent disturbance of sensitive areas, their buffers, and other areas required to be left undisturbed; (3) limit construction traffic to designated construction entrances or roads; and, (4) protect areas where marking with survey tape may not provide adequate protection.

***Conditions of Use*** To establish clearing limits, plastic or metal fence may be used:

- At the boundary of sensitive areas, their buffers, and other areas required to be left uncleared.
- As necessary to control vehicle access to and on the site.

***Design and  
Installation  
Specifications***

- High visibility plastic fence shall be composed of a high-density polyethylene material and shall be at least four feet in height. Posts for the fencing shall be steel or wood and placed every 6 feet on center (maximum) or as needed to ensure rigidity. The fencing shall be fastened to the post every six inches with a polyethylene tie. On long continuous lengths of fencing, a tension wire or rope shall be used as a top stringer to prevent sagging between posts. The fence color shall be high visibility orange. The fence tensile strength shall be 360 lbs./ft. using the ASTM D4595 testing method.
- Metal fences shall be designed and installed according to the manufacturer's specifications.
- Metal fences shall be at least 3 feet high and must be highly visible.
- Fences shall not be wired or stapled to trees.

***Maintenance  
Standards***

- If the fence has been damaged or visibility reduced, it shall be repaired or replaced immediately and visibility restored.

## **BMP C105: Stabilized Construction Entrance**

**Purpose** Construction entrances are stabilized to reduce the amount of sediment transported onto paved roads by vehicles or equipment by constructing a stabilized pad of quarry spalls at entrances to construction sites.

**Conditions of Use** Construction entrances shall be stabilized wherever traffic will be leaving a construction site and traveling on paved roads or other paved areas within 1,000 feet of the site.

On large commercial, highway, and road projects, the designer should include enough extra materials in the contract to allow for additional stabilized entrances not shown in the initial Construction SWPPP. It is difficult to determine exactly where access to these projects will take place; additional materials will enable the contractor to install them where needed.

### **Design and Installation Specifications**

- See Figure 4.2 for details. Note: the 100' minimum length of the entrance shall be reduced to the maximum practicable size when the size or configuration of the site does not allow the full length (100').
- A separation geotextile shall be placed under the spalls to prevent fine sediment from pumping up into the rock pad. The geotextile shall meet the following standards:

Grab Tensile Strength (ASTM D4751)	200 psi min.
Grab Tensile Elongation (ASTM D4632)	30% max.
Mullen Burst Strength (ASTM D3786-80a)	400 psi min.
AOS (ASTM D4751)	20-45 (U.S. standard sieve size)

- Consider early installation of the first lift of asphalt in areas that will paved; this can be used as a stabilized entrance. Also consider the installation of excess concrete as a stabilized entrance. During large concrete pours, excess concrete is often available for this purpose.
- Hog fuel (wood-based mulch) may be substituted for or combined with quarry spalls in areas that will not be used for permanent roads. Hog fuel is generally less effective at stabilizing construction entrances and should be used only at sites where the amount of traffic is very limited. Hog fuel is not recommended for entrance stabilization in urban areas. The effectiveness of hog fuel is highly variable and it generally requires more maintenance than quarry spalls. The inspector may at any time require the use of quarry spalls if the hog fuel is not preventing sediment from being tracked onto pavement or if the hog fuel is being carried onto pavement. Hog fuel is prohibited in permanent roadbeds because organics in the subgrade soils cause degradation of the subgrade support over time.
- Fencing (see BMPs C103 and C104) shall be installed as necessary to restrict traffic to the construction entrance.

**Maintenance Standards**

- Whenever possible, the entrance shall be constructed on a firm, compacted subgrade. This can substantially increase the effectiveness of the pad and reduce the need for maintenance.
- Quarry spalls (or hog fuel) shall be added if the pad is no longer in accordance with the specifications.
- If the entrance is not preventing sediment from being tracked onto pavement, then alternative measures to keep the streets free of sediment shall be used. This may include street sweeping, an increase in the dimensions of the entrance, or the installation of a wheel wash.
- Any sediment that is tracked onto pavement shall be removed by shoveling or street sweeping. The sediment collected by sweeping shall be removed or stabilized on site. The pavement shall not be cleaned by washing down the street, except when sweeping is ineffective and there is a threat to public safety. If it is necessary to wash the streets, the construction of a small sump shall be considered. The sediment would then be washed into the sump where it can be controlled.
- Any quarry spalls that are loosened from the pad, which end up on the roadway shall be removed immediately.
- If vehicles are entering or exiting the site at points other than the construction entrance(s), fencing (see BMPs C103 and C104) shall be installed to control traffic.
- Upon project completion and site stabilization, all construction accesses intended as permanent access for maintenance shall be permanently stabilized.

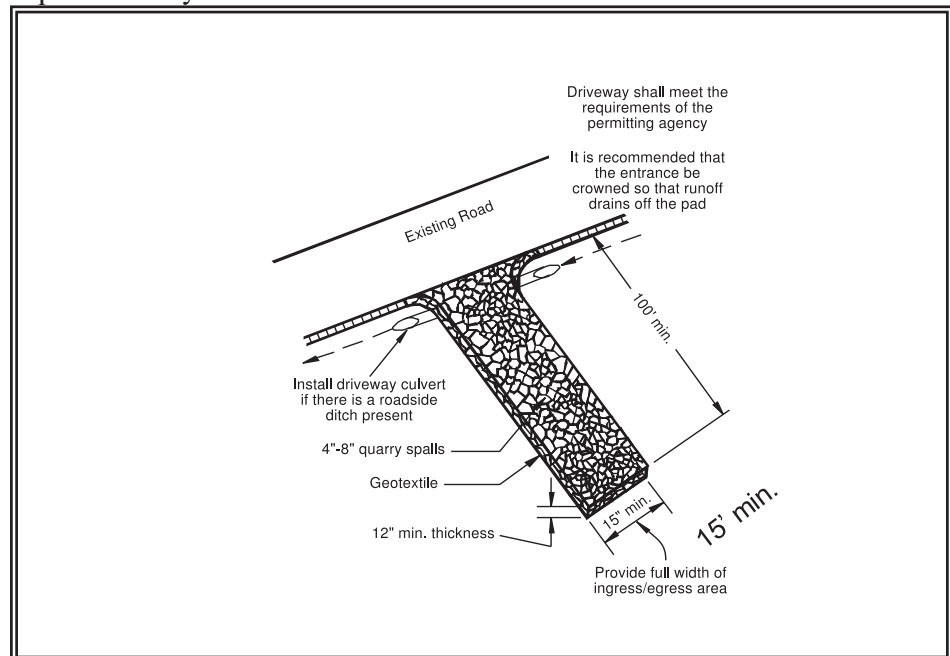

**Figure 4.2 – Stabilized Construction Entrance**

## **BMP C106: Wheel Wash**

### ***Purpose***

Wheel washes reduce the amount of sediment transported onto paved roads by motor vehicles.

### ***Conditions of Use***

When a stabilized construction entrance (see BMP C105) is not preventing sediment from being tracked onto pavement.

- Wheel washing is generally an effective BMP when installed with careful attention to topography. For example, a wheel wash can be detrimental if installed at the top of a slope abutting a right-of-way where the water from the dripping truck can run unimpeded into the street.
- Pressure washing combined with an adequately sized and surfaced pad with direct drainage to a large 10-foot x 10-foot sump can be very effective.

### ***Design and Installation Specifications***

Suggested details are shown in Figure 4.3. The Local Permitting Authority may allow other designs. A minimum of 6 inches of asphalt treated base (ATB) over crushed base material or 8 inches over a good subgrade is recommended to pave the wheel wash.

Use a low clearance truck to test the wheel wash before paving. Either a belly dump or lowboy will work well to test clearance.

Keep the water level from 12 to 14 inches deep to avoid damage to truck hubs and filling the truck tongues with water.

Midpoint spray nozzles are only needed in extremely muddy conditions.

Wheel wash systems should be designed with a small grade change, 6 to 12 inches for a 10-foot-wide pond, to allow sediment to flow to the low side of pond to help prevent re-suspension of sediment. A drainpipe with a 2- to 3-foot riser should be installed on the low side of the pond to allow for easy cleaning and refilling. Polymers may be used to promote coagulation and flocculation in a closed-loop system. Polyacrylamide (PAM) added to the wheel wash water at a rate of 0.25 - 0.5 pounds per 1,000 gallons of water increases effectiveness and reduces cleanup time. If PAM is already being used for dust or erosion control and is being applied by a water truck, the same truck can be used to change the wash water.

### ***Maintenance Standards***

The wheel wash should start out the day with fresh water.

The wash water should be changed a minimum of once per day. On large earthwork jobs where more than 10-20 trucks per hour are expected, the wash water will need to be changed more often.

Wheel wash or tire bath wastewater shall be discharged to a separate on-site treatment system, such as closed-loop recirculation or land application, or to the sanitary sewer with proper local sewer district approval.



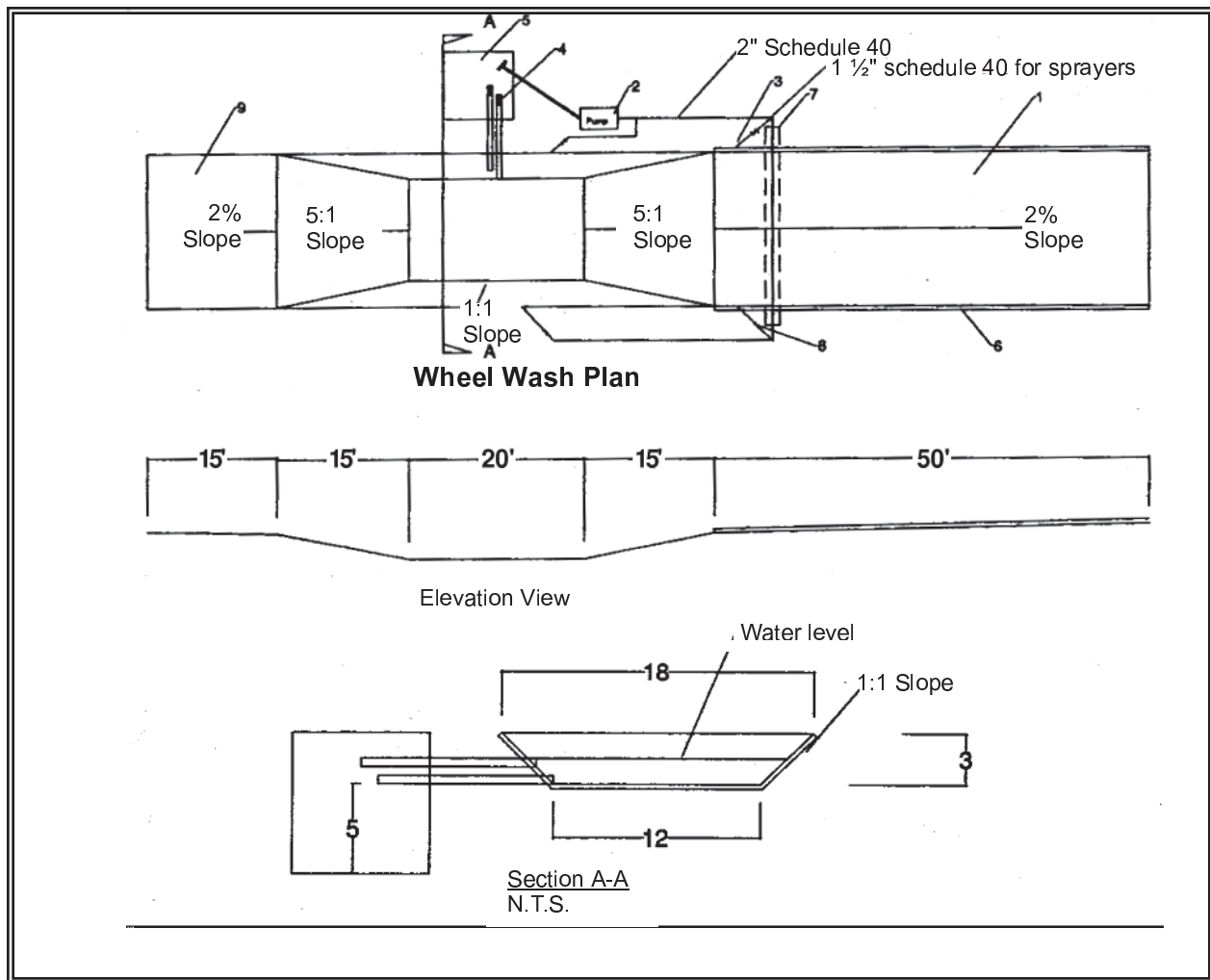

**Figure 4.3 Wheel Wash**

**Notes:**

1. Asphalt construction entrance 6 in. asphalt treated base (ATB).
2. 3-inch trash pump with floats on the suction hose.
3. Midpoint spray nozzles, if needed.
4. 6-inch sewer pipe with butterfly valves. Bottom one is a drain. Locate top pipe's invert 1 foot above bottom of wheel wash.
5. 8 foot x 8 foot sump with 5 feet of catch. Build so can be cleaned with trackhoe.
6. Asphalt curb on the low road side to direct water back to pond.
7. 6-inch sleeve under road.
8. Ball valves.
9. 15 foot. ATB apron to protect ground from splashing water.

## **BMP C107: Construction Road/Parking Area Stabilization**

### ***Purpose***

Stabilizing subdivision roads, parking areas, and other onsite vehicle transportation routes immediately after grading reduces erosion caused by construction traffic or runoff.

### ***Conditions of Use***

- Roads or parking areas shall be stabilized wherever they are constructed, whether permanent or temporary, for use by construction traffic.
- Fencing (see BMPs C103 and C104) shall be installed, if necessary, to limit the access of vehicles to only those roads and parking areas that are stabilized.

### ***Design and Installation Specifications***

- On areas that will receive asphalt as part of the project, install the first lift as soon as possible.
- A 6-inch depth of 2- to 4-inch crushed rock, gravel base, or crushed surfacing base course shall be applied immediately after grading or utility installation. A 4-inch course of asphalt treated base (ATB) may also be used, or the road/parking area may be paved. It may also be possible to use cement or calcium chloride for soil stabilization. If cement or cement kiln dust is used for roadbase stabilization, pH monitoring and BMPs are necessary to evaluate and minimize the effects on stormwater. If the area will not be used for permanent roads, parking areas, or structures, a 6-inch depth of hog fuel may also be used, but this is likely to require more maintenance. Whenever possible, construction roads and parking areas shall be placed on a firm, compacted subgrade.
- Temporary road gradients shall not exceed 15 percent. Roadways shall be carefully graded to drain. Drainage ditches shall be provided on each side of the roadway in the case of a crowned section, or on one side in the case of a super-elevated section. Drainage ditches shall be directed to a sediment control BMP.
- Rather than relying on ditches, it may also be possible to grade the road so that runoff sheet-flows into a heavily vegetated area with a well-developed topsoil. Landscaped areas are not adequate. If this area has at least 50 feet of vegetation, then it is generally preferable to use the vegetation to treat runoff, rather than a sediment pond or trap. The 50 feet shall not include wetlands. If runoff is allowed to sheetflow through adjacent vegetated areas, it is vital to design the roadways and parking areas so that no concentrated runoff is created.

### ***Maintenance Standards***

- Storm drain inlets shall be protected to prevent sediment-laden water entering the storm drain system (see BMP C220).
- Inspect stabilized areas regularly, especially after large storm events.
- Crushed rock, gravel base, hog fuel, etc. shall be added as required to maintain a stable driving surface and to stabilize any areas that have eroded.
- Following construction, these areas shall be restored to pre-construction condition or better to prevent future erosion.

## **BMP C120: Temporary and Permanent Seeding**

### ***Purpose***

Seeding is intended to reduce erosion by stabilizing exposed soils. A well-established vegetative cover is one of the most effective methods of reducing erosion.

### ***Conditions of Use***

- Seeding may be used throughout the project on disturbed areas that have reached final grade or that will remain unworked for more than 30 days.
- Channels that will be vegetated should be installed before major earthwork and hydroseeded with a Bonded Fiber Matrix. The vegetation should be well established (i.e., 75 percent cover) before water is allowed to flow in the ditch. With channels that will have high flows, erosion control blankets should be installed over the hydroseed. If vegetation cannot be established from seed before water is allowed in the ditch, sod should be installed in the bottom of the ditch over hydromulch and blankets.
- Retention/detention ponds should be seeded as required.
- Mulch is required at all times because it protects seeds from heat, moisture loss, and transport due to runoff.
- All disturbed areas shall be reviewed in late August to early September and all seeding should be completed by the end of September. Otherwise, vegetation will not establish itself enough to provide more than average protection.
- At final site stabilization, all disturbed areas not otherwise vegetated or stabilized shall be seeded and mulched. Final stabilization means the completion of all soil disturbing activities at the site and the establishment of a permanent vegetative cover, or equivalent permanent stabilization measures (such as pavement, riprap, gabions or geotextiles) which will prevent erosion.
- Seeding should be done during those seasons most conducive to growth and will vary with the climate conditions of the region. Local experience should be used to determine the appropriate seeding periods.
- The optimum seeding windows for western Washington are April 1 through June 30 and September 1 through October 1. Seeding that occurs between July 1 and August 30 will require irrigation until 75 percent grass cover is established. Seeding that occurs between October 1 and March 30 will require a mulch or plastic cover until 75 percent grass cover is established.
- To prevent seed from being washed away, confirm that all required surface water control measures have been installed.

### ***Design and Installation Specifications***

- The seedbed should be firm and rough. All soil should be roughened no matter what the slope. If compaction is required for engineering purposes, slopes must be track walked before seeding. Backblading or smoothing of slopes greater than 4:1 is not allowed if they are to be seeded.
- New and more effective restoration-based landscape practices rely on deeper incorporation than that provided by a simple single-pass rototilling treatment. Wherever practical the subgrade should be initially ripped to improve long-term permeability, infiltration, and water inflow qualities. At a minimum, permanent areas shall use soil amendments to achieve organic matter and permeability performance defined in engineered soil/landscape systems. For systems that are deeper than 8 inches the rototilling process should be done in multiple lifts, or the prepared soil system shall be prepared properly and then placed to achieve the specified depth.
- Organic matter is the most appropriate form of “fertilizer” because it provides nutrients (including nitrogen, phosphorus, and potassium) in the least water-soluble form. A natural system typically releases 2-10 percent of its nutrients annually. Chemical fertilizers have since been formulated to simulate what organic matter does naturally.
- In general, 10-4-6 N-P-K (nitrogen-phosphorus-potassium) fertilizer can be used at a rate of 90 pounds per acre. Slow-release fertilizers should always be used because they are more efficient and have fewer environmental impacts. It is recommended that areas being seeded for final landscaping conduct soil tests to determine the exact type and quantity of fertilizer needed. This will prevent the over-application of fertilizer. Fertilizer should not be added to the hydromulch machine and agitated more than 20 minutes before it is to be used. If agitated too much, the slow-release coating is destroyed.
- There are numerous products available on the market that take the place of chemical fertilizers. These include several with seaweed extracts that are beneficial to soil microbes and organisms. If 100 percent cottonseed meal is used as the mulch in hydroseed, chemical fertilizer may not be necessary. Cottonseed meal is a good source of long-term, slow-release, available nitrogen.
- Hydroseed applications shall include a minimum of 1,500 pounds per acre of mulch with 3 percent tackifier. Mulch may be made up of 100 percent: cottonseed meal; fibers made of wood, recycled cellulose, hemp, and kenaf; compost; or blends of these. Tackifier shall be plant-based, such as guar or alpha plantago, or chemical-based such as polyacrylamide or polymers. Any mulch or tackifier product used shall be installed per manufacturer’s instructions. Generally, mulches come in 40-50 pound bags. Seed and fertilizer are added at time of application.

- Mulch is always required for seeding. Mulch can be applied on top of the seed or simultaneously by hydroseeding.
- On steep slopes, Bonded Fiber Matrix (BFM) or Mechanically Bonded Fiber Matrix (MBFM) products should be used. BFM/MBFM products are applied at a minimum rate of 3,000 pounds per acre of mulch with approximately 10 percent tackifier. Application is made so that a minimum of 95 percent soil coverage is achieved. Numerous products are available commercially and should be installed per manufacturer's instructions. Most products require 24-36 hours to cure before a rainfall and cannot be installed on wet or saturated soils. Generally, these products come in 40-50 pound bags and include all necessary ingredients except for seed and fertilizer.

BFMs and MBFMs have some advantages over blankets:

- No surface preparation required;
- Can be installed via helicopter in remote areas;
- On slopes steeper than 2.5:1, blanket installers may need to be roped and harnessed for safety;
- They are at least \$1,000 per acre cheaper installed.

In most cases, the shear strength of blankets is not a factor when used on slopes, only when used in channels. BFMs and MBFMs are good alternatives to blankets in most situations where vegetation establishment is the goal.

- When installing seed via hydroseeding operations, only about 1/3 of the seed actually ends up in contact with the soil surface. This reduces the ability to establish a good stand of grass quickly. One way to overcome this is to increase seed quantities by up to 50 percent.
- Vegetation establishment can also be enhanced by dividing the hydromulch operation into two phases:
  1. Phase 1- Install all seed and fertilizer with 25-30 percent mulch and tackifier onto soil in the first lift;
  2. Phase 2- Install the rest of the mulch and tackifier over the first lift.

An alternative is to install the mulch, seed, fertilizer, and tackifier in one lift. Then, spread or blow straw over the top of the hydromulch at a rate of about 800-1000 pounds per acre. Hold straw in place with a standard tackifier. Both of these approaches will increase cost moderately but will greatly improve and enhance vegetative establishment. The increased cost may be offset by the reduced need for:

1. Irrigation
2. Reapplication of mulch
3. Repair of failed slope surfaces

This technique works with standard hydromulch (1,500 pounds per acre minimum) and BFM/MBFMs (3,000 pounds per acre minimum).

- Areas to be permanently landscaped shall provide a healthy topsoil that reduces the need for fertilizers, improves overall topsoil quality, provides for better vegetal health and vitality, improves hydrologic characteristics, and reduces the need for irrigation. This can be accomplished in a number of ways:

Recent research has shown that the best method to improve till soils is to amend these soils with compost. The optimum mixture is approximately two parts soil to one part compost. This equates to 4 inches of compost mixed to a depth of 12 inches in till soils. Increasing the concentration of compost beyond this level can have negative effects on vegetal health, while decreasing the concentrations can reduce the benefits of amended soils. Please note: The compost should meet specifications for Grade A quality compost in Ecology Publication 94-038.

Other soils, such as gravel or cobble outwash soils, may require different approaches. Organics and fines easily migrate through the loose structure of these soils. Therefore, the importation of at least 6 inches of quality topsoil, underlain by some type of filter fabric to prevent the migration of fines, may be more appropriate for these soils.

Areas that already have good topsoil, such as undisturbed areas, do not require soil amendments.

- Areas that will be seeded only and not landscaped may need compost or meal-based mulch included in the hydroseed in order to establish vegetation. Native topsoil should be re-installed on the disturbed soil surface before application.
- Seed that is installed as a temporary measure may be installed by hand if it will be covered by straw, mulch, or topsoil. Seed that is installed as a permanent measure may be installed by hand on small areas (usually less than 1 acre) that will be covered with mulch, topsoil, or erosion blankets. The seed mixes listed below include recommended mixes for both temporary and permanent seeding. These mixes, with the exception of the wetland mix, shall be applied at a rate of 120 pounds per acre. This rate can be reduced if soil amendments or slow-release fertilizers are used. Local suppliers or the local conservation district should be consulted for their recommendations because the appropriate mix depends on a variety of factors, including location, exposure, soil type, slope, and expected foot traffic. Alternative seed mixes approved by the local authority may be used.

Table 4.1 represents the standard mix for those areas where just a temporary vegetative cover is required.

<b>Table 4.1 Temporary Erosion Control Seed Mix</b>			
	<b>% Weight</b>	<b>% Purity</b>	<b>% Germination</b>
Chewings or annual blue grass <i>Festuca rubra var. commutata</i> or <i>Poa anna</i>	40	98	90
Perennial rye - <i>Lolium perenne</i>	50	98	90
Redtop or colonial bentgrass <i>Agrostis alba</i> or <i>Agrostis tenuis</i>	5	92	85
White dutch clover <i>Trifolium repens</i>	5	98	90

Table 4.2 provides just one recommended possibility for landscaping seed.

<b>Table 4.2 Landscaping Seed Mix</b>			
	<b>% Weight</b>	<b>% Purity</b>	<b>% Germination</b>
Perennial rye blend <i>Lolium perenne</i>	70	98	90
Chewings and red fescue blend <i>Festuca rubra var. commutata</i> or <i>Festuca rubra</i>	30	98	90

This turf seed mix in Table 4.3 is for dry situations where there is no need for much water. The advantage is that this mix requires very little maintenance.

<b>Table 4.3 Low-Growing Turf Seed Mix</b>			
	<b>% Weight</b>	<b>% Purity</b>	<b>% Germination</b>
Dwarf tall fescue (several varieties) <i>Festuca arundinacea var.</i>	45	98	90
Dwarf perennial rye (Barclay) <i>Lolium perenne var. barclay</i>	30	98	90
Red fescue <i>Festuca rubra</i>	20	98	90
Colonial bentgrass <i>Agrostis tenuis</i>	5	98	90

Table 4.4 presents a mix recommended for bioswales and other intermittently wet areas.

<b>Table 4.4 Bioswale Seed Mix*</b>			
	<b>% Weight</b>	<b>% Purity</b>	<b>% Germination</b>
Tall or meadow fescue <i>Festuca arundinacea</i> or <i>Festuca elatior</i>	75-80	98	90
Seaside/Creeping bentgrass <i>Agrostis palustris</i>	10-15	92	85
Redtop bentgrass <i>Agrostis alba</i> or <i>Agrostis gigantea</i>	5-10	90	80

\* Modified Briargreen, Inc. Hydroseeding Guide Wetlands Seed Mix

The seed mix shown in Table 4.5 is a recommended low-growing, relatively non-invasive seed mix appropriate for very wet areas that are not regulated wetlands. Other mixes may be appropriate, depending on the soil type and hydrology of the area. Recent research suggests that bentgrass (*agrostis* sp.) should be emphasized in wet-area seed mixes. Apply this mixture at a rate of 60 pounds per acre.

<b>Table 4.5 Wet Area Seed Mix*</b>			
	<b>% Weight</b>	<b>% Purity</b>	<b>% Germination</b>
Tall or meadow fescue <i>Festuca arundinacea</i> or <i>Festuca elatior</i>	60-70	98	90
Seaside/Creeping bentgrass <i>Agrostis palustris</i>	10-15	98	85
Meadow foxtail <i>Alepcurus pratensis</i>	10-15	90	80
Alsike clover <i>Trifolium hybridum</i>	1-6	98	90
Redtop bentgrass <i>Agrostis alba</i>	1-6	92	85

\* Modified Briargreen, Inc. Hydroseeding Guide Wetlands Seed Mix

The meadow seed mix in Table 4.6 is recommended for areas that will be maintained infrequently or not at all and where colonization by native plants is desirable. Likely applications include rural road and utility right-of-way. Seeding should take place in September or very early October in order to obtain adequate establishment prior to the winter months. The appropriateness of clover in the mix may need to be considered, as this can be a fairly invasive species. If the soil is amended, the addition of clover may not be necessary.

<b>Table 4.6 Meadow Seed Mix</b>			
	<b>% Weight</b>	<b>% Purity</b>	<b>% Germination</b>
Redtop or Oregon bentgrass <i>Agrostis alba</i> or <i>Agrostis oregonensis</i>	20	92	85
Red fescue <i>Festuca rubra</i>	70	98	90
White dutch clover <i>Trifolium repens</i>	10	98	90

**Maintenance Standards**

- Any seeded areas that fail to establish at least 80 percent cover (100 percent cover for areas that receive sheet or concentrated flows) shall be reseeded. If reseeding is ineffective, an alternate method, such as sodding, mulching, or nets/blankets, shall be used. If winter weather prevents adequate grass growth, this time limit may be relaxed at the discretion of the local authority when sensitive areas would otherwise be protected.



- After adequate cover is achieved, any areas that experience erosion shall be reseeded and protected by mulch. If the erosion problem is drainage related, the problem shall be fixed and the eroded area reseeded and protected by mulch.
- Seeded areas shall be supplied with adequate moisture, but not watered to the extent that it causes runoff.

# BMP C121: Mulching

## *Purpose*

Mulching soils provides immediate temporary protection from erosion. Mulch also enhances plant establishment by conserving moisture, holding fertilizer, seed, and topsoil in place, and moderating soil temperatures. There is an enormous variety of mulches that can be used. This section discusses only the most common types of mulch.

## *Conditions of Use*

As a temporary cover measure, mulch should be used:

- For less than 30 days on disturbed areas that require cover.
- At all times for seeded areas, especially during the wet season and during the hot summer months.
- During the wet season on slopes steeper than 3H:1V with more than 10 feet of vertical relief.

Mulch may be applied at any time of the year and must be refreshed periodically.

- For seeded areas mulch may be made up of 100 percent: cottonseed meal; fibers made of wood, recycled cellulose, hemp, kenaf; compost; or blends of these. Tackifier shall be plant-based, such as guar or alpha plantago, or chemical-based such as polyacrylamide or polymers. Any mulch or tackifier product used shall be installed per manufacturer's instructions. Generally, mulches come in 40-50 pound bags. Seed and fertilizer are added at time of application.

## *Design and Installation Specifications*

For mulch materials, application rates, and specifications, see [Table II-4.1.8 Mulch Standards and Guidelines](#). Always use a 2-inch minimum mulch thickness; increase the thickness until the ground is 95% covered (i.e. not visible under the mulch layer). Note: Thickness may be increased for disturbed areas in or near sensitive areas or other areas highly susceptible to erosion.

Where the option of "Compost" is selected, it should be a coarse compost that meets the following size gradations when tested in accordance with the U.S. Composting Council "Test Methods for the Examination of Compost and Composting" (TMECC) Test Method 02.02-B.

### Coarse Compost

Minimum Percent passing 3" sieve openings 100%

Minimum Percent passing 1" sieve openings 90%

Minimum Percent passing ¾" sieve openings 70%

Minimum Percent passing ¼" sieve openings 40%

Mulch used within the ordinary high-water mark of surface waters should be selected to minimize potential flotation of organic matter. Composted organic materials have higher specific gravities (densities) than straw, wood, or chipped material. Consult Hydraulic Permit Authority (HPA) for mulch mixes if applicable.

### **Maintenance Standards**

- The thickness of the cover must be maintained.
- Any areas that experience erosion shall be remulched and/or protected with a net or blanket. If the erosion problem is drainage related, then the problem shall be fixed and the eroded area remulched.

**Table II-4.1.8 Mulch Standards and Guidelines**

<b>Mulch Material</b>	<b>Quality Standards</b>	<b>Application Rates</b>	<b>Remarks</b>
Straw	Air-dried; free from undesirable seed and coarse material.	2"-3" thick; 5 bales per 1,000 sf or 2-3 tons per acre	Cost-effective protection when applied with adequate thickness. Hand-application generally requires greater thickness than blown straw. The thickness of straw may be reduced by half when used in conjunction with seeding. In windy areas straw must be held in place by crimping, using a tackifier, or covering with netting. Blown straw always has to be held in place with a tackifier as even light winds will blow it away. Straw, however, has several deficiencies that should be considered when selecting mulch materials. It often introduces and/or encourages the propagation of weed species and it has no significant long-term benefits It should also not be used within the ordinary high-water elevation of surface waters (due to flotation).
Hydromulch	No growth inhibiting factors.	Approx. 25-30 lbs per 1,000 sf or 1,500 - 2,000 lbs per acre	Shall be applied with hydromulcher. Shall not be used without seed and tackifier unless the application rate is at least doubled. Fibers longer than about ¾ - 1 inch clog hydromulch equipment. Fibers should be kept to less than ¾ inch.

Mulch Material	Quality Standards	Application Rates	Remarks
Compost	No visible water or dust during handling. Must be produced per WAC 173-350, Solid Waste Handling Standards, but may have up to 35% biosolids.	2" thick min.; approx. 100 tons per acre (approx. 800 lbs per yard)	More effective control can be obtained by increasing thickness to 3". Excellent mulch for protecting final grades until landscaping because it can be directly seeded or tilled into soil as an amendment. Compost used for mulch has a coarser size gradation than compost used for <a href="#">BMP C125: Topsoiling / Composting</a> or <a href="#">BMP T5.13: Post-Construction Soil Quality and Depth</a> . It is more stable and practical to use in wet areas and during rainy weather conditions. Do not use near wetlands or near phosphorous impaired water bodies.
Chipped Site Vegetation	Average size shall be several inches. Gradations from fines to 6 inches in length for texture, variation, and interlocking properties.	2" thick min.;	This is a cost-effective way to dispose of debris from clearing and grubbing, and it eliminates the problems associated with burning. Generally, it should not be used on slopes above approx. 10% because of its tendency to be transported by runoff. It is not recommended within 200 feet of surface waters. If seeding is expected shortly after mulch, the decomposition of the chipped vegetation may tie up nutrients important to grass establishment.
Wood-based Mulch or Wood Straw	No visible water or dust during handling. Must be purchased from a supplier with a Solid Waste Handling Permit or one exempt from solid waste regulations.	2" thick min.; approx. 100 tons per acre (approx. 800 lbs. per cubic yard)	This material is often called "hog or hogged fuel". □ The use of mulch ultimately improves the organic matter in the soil. Special caution is advised regarding the source and composition of wood-based mulches. Its preparation typically does not provide any weed seed control, so evidence of residual vegetation in its composition or known inclusion of weed plants or seeds should be monitored and prevented (or minimized).
Wood Strand Mulch	A blend of loose, long, thin wood pieces derived from native conifer or deciduous trees with high length-to-width ratio.	2" thick min.	Cost-effective protection when applied with adequate thickness. A minimum of 95-percent of the wood strand shall have lengths between 2 and 10-inches, with a width and thickness between 1/16 and 3/8-inches. The mulch shall not contain resin, tannin, or other compounds in quantities that would be detrimental to plant life. Sawdust or wood shavings shall not be used as mulch. (WSDOT specification (9-14.4(4)))

# BMP C122: Nets and Blankets

## *Purpose*

Erosion control nets and blankets are intended to prevent erosion and hold seed and mulch in place on steep slopes and in channels so that vegetation can become well established. In addition, some nets and blankets can be used to permanently reinforce turf to protect drainage ways during high flows. Nets (commonly called matting) are strands of material woven into an open, but high-tensile strength net (for example, coconut fiber matting). Blankets are strands of material that are not tightly woven, but instead form a layer of interlocking fibers, typically held together by a biodegradable or photodegradable netting (for example, excelsior or straw blankets). They generally have lower tensile strength than nets, but cover the ground more completely. Coir (coconut fiber) fabric comes as both nets and blankets.

## *Conditions of Use*

Erosion control nets and blankets should be used:

- To aid permanent vegetated stabilization of slopes 2H:1V or greater and with more than 10 feet of vertical relief.
- For drainage ditches and swales (highly recommended). The application of appropriate netting or blanket to drainage ditches and swales can protect bare soil from channelized runoff while vegetation is established. Nets and blankets also can capture a great deal of sediment due to their open, porous structure. Nets and blankets can be used to permanently stabilize channels and may provide a cost-effective, environmentally preferable alternative to riprap. 100 percent synthetic blankets manufactured for use in ditches may be easily reused as temporary ditch liners.

Disadvantages of blankets include:

- Surface preparation required.
- On slopes steeper than 2.5H:1V, blanket installers may need to be roped and harnessed for safety.
- They cost at least \$4,000-6,000 per acre installed.

Advantages of blankets include:

- Installation without mobilizing special equipment.
- Installation by anyone with minimal training
- Installation in stages or phases as the project progresses.

- Installers can hand place seed and fertilizer as they progress down the slope.
- Installation in any weather.
- There are numerous types of blankets that can be designed with various parameters in mind. Those parameters include: fiber blend, mesh strength, longevity, biodegradability, cost, and availability.

### ***Design and Installation Specifications***

- See [Figure II-4.1.3 Channel Installation](#) and [Figure II-4.1.4 Slope Installation](#) for typical orientation and installation of blankets used in channels and as slope protection. Note: these are typical only; all blankets must be installed per manufacturer's installation instructions.
- Installation is critical to the effectiveness of these products. If good ground contact is not achieved, runoff can concentrate under the product, resulting in significant erosion.
- Installation of Blankets on Slopes:
  1. Complete final grade and track walk up and down the slope.
  2. Install hydromulch with seed and fertilizer.
  3. Dig a small trench, approximately 12 inches wide by 6 inches deep along the top of the slope.
  4. Install the leading edge of the blanket into the small trench and staple approximately every 18 inches. NOTE: Staples are metal, "U"-shaped, and a minimum of 6 inches long. Longer staples are used in sandy soils. Biodegradable stakes are also available.
  5. Roll the blanket slowly down the slope as installer walks backwards. NOTE: The blanket rests against the installer's legs. Staples are installed as the blanket is unrolled. It is critical that the proper staple pattern is used for the blanket being installed. The blanket is not to be allowed to roll down the slope on its own as this stretches the blanket making it impossible to maintain soil contact. In addition, no one is allowed to walk on the blanket after it is in place.
  6. If the blanket is not long enough to cover the entire slope length, the trailing edge of the upper blanket should overlap the leading edge of the lower blanket and be stapled. On steeper slopes, this overlap should be installed in a small trench, stapled, and covered with soil.

- With the variety of products available, it is impossible to cover all the details of appropriate use and installation. Therefore, it is critical that the design engineer consult the manufacturer's information and that a site visit takes place in order to ensure that the product specified is appropriate. Information is also available at the following web sites:

1. WSDOT (Section 3.2.4):

<http://www.wsdot.wa.gov/NR/rdonlyres/3B41E087-FA86-4717-932D-D7A8556CCD57/0/ErosionTrainingManual.pdf>

2. Texas Transportation Institute:

[http://www.txdot.gov/business/doing\\_business/product\\_evaluation/erosion\\_control.htm](http://www.txdot.gov/business/doing_business/product_evaluation/erosion_control.htm)

- Use jute matting in conjunction with mulch ([BMP C121: Mulching](#)). Excelsior, woven straw blankets and coir (coconut fiber) blankets may be installed without mulch. There are many other types of erosion control nets and blankets on the market that may be appropriate in certain circumstances.
- In general, most nets (e.g., jute matting) require mulch in order to prevent erosion because they have a fairly open structure. Blankets typically do not require mulch because they usually provide complete protection of the surface.
- Extremely steep, unstable, wet, or rocky slopes are often appropriate candidates for use of synthetic blankets, as are riverbanks, beaches and other high-energy environments. If synthetic blankets are used, the soil should be hydromulched first.
- 100-percent biodegradable blankets are available for use in sensitive areas. These organic blankets are usually held together with a paper or fiber mesh and stitching which may last up to a year.
- Most netting used with blankets is photodegradable, meaning they break down under sunlight (not UV stabilized). However, this process can take months or years even under bright sun. Once vegetation is established, sunlight does not reach the mesh. It is not uncommon to find non-degraded netting still in place several years after installation. This can be a problem if maintenance requires the use of mowers or ditch cleaning equipment. In addition, birds and small animals can become trapped in the netting.

### ***Maintenance Standards***

- Maintain good contact with the ground. Erosion must not occur beneath the net or blanket.

- Repair and staple any areas of the net or blanket that are damaged or not in close contact with the ground.
- Fix and protect eroded areas if erosion occurs due to poorly controlled drainage.

### **Figure II-4.1.3 Channel Installation**

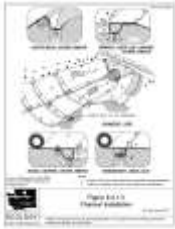

[2014 Figure II-4.1.3 pdf download](#)

### **Figure II-4.1.4 Slope Installation**



[2014 Figure II-4.1.4 pdf download](#)

---

*Washington State Department of Ecology*

[2012 Stormwater Management Manual for Western Washington, as Amended in December 2014. \(The 2014 SWMMWW\)](#)



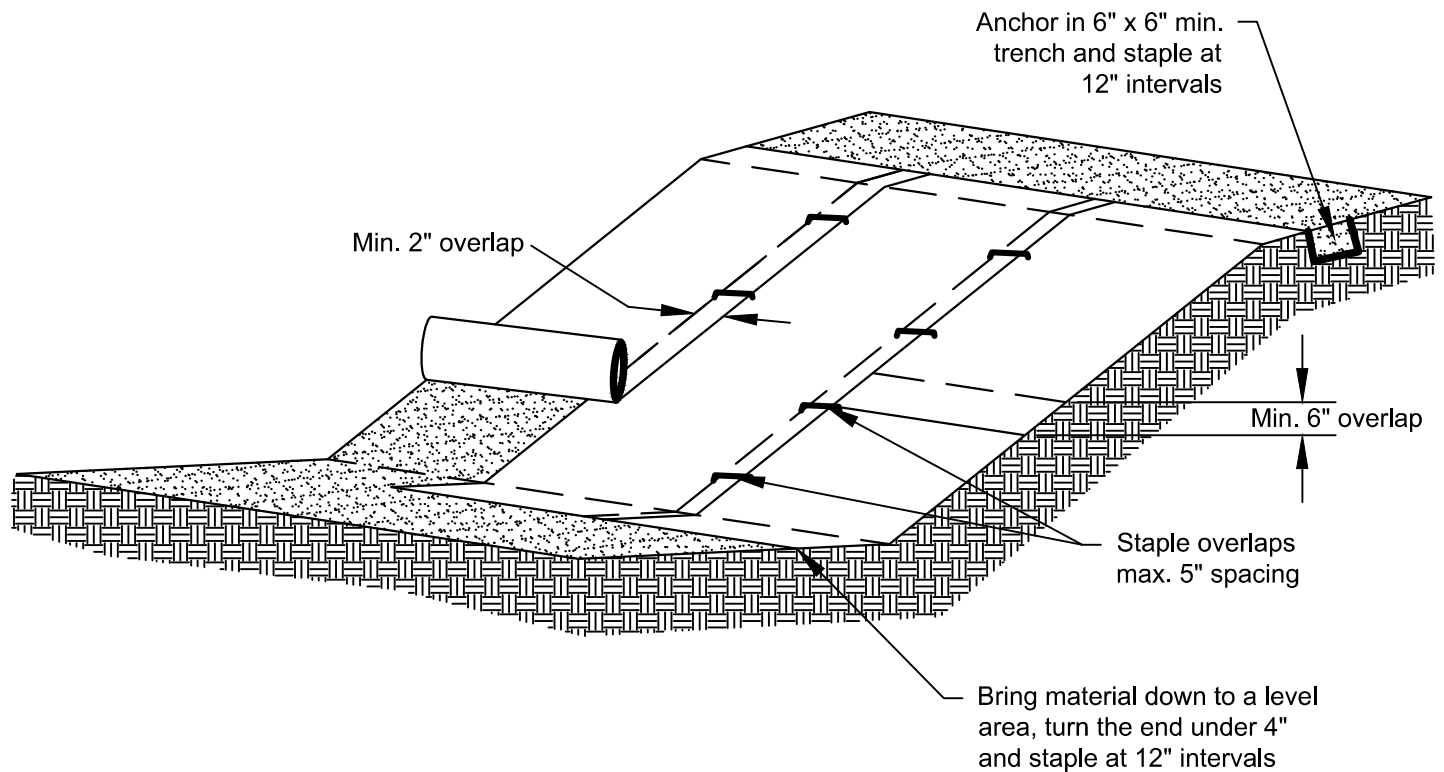

Notes:

1. Slope surface shall be smooth before placement for proper soil contact.
2. Stapling pattern as per manufacturer's recommendations.
3. Do not stretch blankets/mattings tight - allow the rolls to mold to any irregularities.
4. For slopes less than 3H:1V, rolls may be placed in horizontal strips.
5. If there is a berm at the top of the slope, anchor upslope of the berm.
6. Lime, fertilize, and seed before installation. Planting of shrubs, trees, etc. should occur after installation.

NOT TO SCALE

## **BMP C123: Plastic Covering**

*Purpose* Plastic covering provides immediate, short-term erosion protection to slopes and disturbed areas.

- Conditions of Use*
- Plastic covering may be used on disturbed areas that require cover measures for less than 30 days, except as stated below.
  - Plastic is particularly useful for protecting cut and fill slopes and stockpiles. Note: The relatively rapid breakdown of most polyethylene sheeting makes it unsuitable for long-term (greater than six months) applications.
  - Clear plastic sheeting can be used over newly-seeded areas to create a greenhouse effect and encourage grass growth if the hydroseed was installed too late in the season to establish 75 percent grass cover, or if the wet season started earlier than normal. Clear plastic should not be used for this purpose during the summer months because the resulting high temperatures can kill the grass.
  - Due to rapid runoff caused by plastic sheeting, this method shall not be used upslope of areas that might be adversely impacted by concentrated runoff. Such areas include steep and/or unstable slopes.
  - While plastic is inexpensive to purchase, the added cost of installation, maintenance, removal, and disposal make this an expensive material, up to \$1.50-2.00 per square yard.
  - Whenever plastic is used to protect slopes, water collection measures must be installed at the base of the slope. These measures include plastic-covered berms, channels, and pipes used to convey clean rainwater away from bare soil and disturbed areas. At no time is clean runoff from a plastic covered slope to be mixed with dirty runoff from a project.
  - Other uses for plastic include:
    1. Temporary ditch liner;
    2. Pond liner in temporary sediment pond;
    3. Liner for bermed temporary fuel storage area if plastic is not reactive to the type of fuel being stored;
    4. Emergency slope protection during heavy rains; and,
    5. Temporary drainpipe (“elephant trunk”) used to direct water.

***Design and  
Installation  
Specifications***

- Plastic slope cover must be installed as follows:
  1. Run plastic up and down slope, not across slope;
  2. Plastic may be installed perpendicular to a slope if the slope length is less than 10 feet;
  3. Minimum of 8-inch overlap at seams;
  4. On long or wide slopes, or slopes subject to wind, all seams should be taped;
  5. Place plastic into a small (12-inch wide by 6-inch deep) slot trench at the top of the slope and backfill with soil to keep water from flowing underneath;
  6. Place sand filled burlap or geotextile bags every 3 to 6 feet along seams and pound a wooden stake through each to hold them in place;
  7. Inspect plastic for rips, tears, and open seams regularly and repair immediately. This prevents high velocity runoff from contacting bare soil which causes extreme erosion;
  8. Sandbags may be lowered into place tied to ropes. However, all sandbags must be staked in place.
- Plastic sheeting shall have a minimum thickness of 0.06 millimeters.
- If erosion at the toe of a slope is likely, a gravel berm, riprap, or other suitable protection shall be installed at the toe of the slope in order to reduce the velocity of runoff.

***Maintenance  
Standards***

- Torn sheets must be replaced and open seams repaired.
- If the plastic begins to deteriorate due to ultraviolet radiation, it must be completely removed and replaced.
- When the plastic is no longer needed, it shall be completely removed.
- Dispose of old tires appropriately.

# BMP C125: Topsoiling / Composting

## *Purpose*

Topsoiling and composting provide a suitable growth medium for final site stabilization with vegetation. While not a permanent cover practice in itself, topsoiling and composting are an integral component of providing permanent cover in those areas where there is an unsuitable soil surface for plant growth. Use this BMP in conjunction with other BMPs such as seeding, mulching, or sodding. Note that this BMP is functionally the same as [BMP T5.13: Post-Construction Soil Quality and Depth](#) which is required for all disturbed areas that will be developed as lawn or landscaped areas at the completed project site.

Native soils and disturbed soils that have been organically amended not only retain much more stormwater, but they also serve as effective biofilters for urban pollutants and, by supporting more vigorous plant growth, reduce the water, fertilizer and pesticides needed to support installed landscapes. Topsoil does not include any subsoils but only the material from the top several inches including organic debris.

## *Conditions of Use*

- Permanent landscaped areas shall contain healthy topsoil that reduces the need for fertilizers, improves overall topsoil quality, provides for better vegetal health and vitality, improves hydrologic characteristics, and reduces the need for irrigation.
- Leave native soils and the duff layer undisturbed to the maximum extent practicable. Stripping of existing, properly functioning soil system and vegetation for the purpose of topsoiling during construction is not acceptable. Preserve existing soil systems in undisturbed and uncompacted conditions if functioning properly.
- Areas that already have good topsoil, such as undisturbed areas, do not require soil amendments.
- Restore, to the maximum extent practical, native soils disturbed during clearing and grading to a condition equal to or better than the original site condition's moisture-holding capacity. Use on-site native topsoil, incorporate amendments into on-site soil, or import blended topsoil to meet this requirement.
- Topsoiling is a required procedure when establishing vegetation on shallow soils, and soils of critically low pH (high acid) levels.
- Beware of where the topsoil comes from, and what vegetation was on site before disturbance, invasive plant seeds may be included and could cause problems for establishing native plants, landscaped areas, or grasses.

- Topsoil from the site will contain mycorrhizal bacteria that are necessary for healthy root growth and nutrient transfer. These native mycorrhiza are acclimated to the site and will provide optimum conditions for establishing grasses. Use commercially available mycorrhiza products when using off-site topsoil.

### ***Design and Installation Specifications***

Meet the following requirements for disturbed areas that will be developed as lawn or landscaped areas at the completed project site:

- Maximize the depth of the topsoil wherever possible to provide the maximum possible infiltration capacity and beneficial growth medium. Topsoil shall have:
  - A minimum depth of 8-inches. Scarify subsoils below the topsoil layer at least 4-inches with some incorporation of the upper material to avoid stratified layers, where feasible. Ripping or re-structuring the subgrade may also provide additional benefits regarding the overall infiltration and interflow dynamics of the soil system.
  - A minimum organic content of 10% dry weight in planting beds, and 5% organic matter content in turf areas. Incorporate organic amendments to a minimum 8-inch depth except where tree roots or other natural features limit the depth of incorporation.
  - A pH between 6.0 and 8.0 or matching the pH of the undisturbed soil.
  - If blended topsoil is imported, then fines should be limited to 25 percent passing through a 200 sieve.
  - Mulch planting beds with 2 inches of organic material
- Accomplish the required organic content, depth, and pH by returning native topsoil to the site, importing topsoil of sufficient organic content, and/or incorporating organic amendments. When using the option of incorporating amendments to meet the organic content requirement, use compost that meets the compost specification for Bioretention (See [BMP T7.30: Bioretention Cells, Swales, and Planter Boxes](#)), with the exception that the compost may have up to 35% biosolids or manure.
- Sections three through seven of the document entitled, *Guidelines and Resources for Implementing Soil Quality and Depth BMP T5.13 in WDOE Stormwater Management Manual for Western Washington*, provides useful guidance for implementing whichever option is chosen. It includes guidance for pre-approved default strategies and guidance for custom strategies. Check with your local jurisdiction concerning its acceptance of this guidance. It is available through the

organization, Soils for Salmon. As of this printing the document may be found at:

[http://www.soilsforsalmon.org/pdf/Soil\\_BMP\\_Manual.pdf](http://www.soilsforsalmon.org/pdf/Soil_BMP_Manual.pdf).

- The final composition and construction of the soil system will result in a natural selection or favoring of certain plant species over time. For example, incorporation of topsoil may favor grasses, while layering with mildly acidic, high-carbon amendments may favor more woody vegetation.
- Allow sufficient time in scheduling for topsoil spreading prior to seeding, sodding, or planting.
- Take care when applying top soil to subsoils with contrasting textures. Sandy topsoil over clayey subsoil is a particularly poor combination, as water creeps along the junction between the soil layers and causes the topsoil to slough. If topsoil and subsoil are not properly bonded, water will not infiltrate the soil profile evenly and it will be difficult to establish vegetation. The best method to prevent a lack of bonding is to actually work the topsoil into the layer below for a depth of at least 6 inches.
- Field exploration of the site shall be made to determine if there is surface soil of sufficient quantity and quality to justify stripping. Topsoil shall be friable and loamy (loam, sandy loam, silt loam, sandy clay loam, and clay loam). Avoid areas of natural ground water recharge.
- Stripping shall be confined to the immediate construction area. A 4-inch to 6-inch stripping depth is common, but depth may vary depending on the particular soil. All surface runoff control structures shall be in place prior to stripping.
- Do not place topsoil while in a frozen or muddy condition, when the subgrade is excessively wet, or when conditions exist that may otherwise be detrimental to proper grading or proposed sodding or seeding.
- In any areas requiring grading remove and stockpile the duff layer and topsoil on site in a designated, controlled area, not adjacent to public resources and critical areas. Stockpiled topsoil is to be reapplied to other portions of the site where feasible.
- Locate the topsoil stockpile so that it meets specifications and does not interfere with work on the site. It may be possible to locate more than one pile in proximity to areas where topsoil will be used.

Stockpiling of topsoil shall occur in the following manner:

- Side slopes of the stockpile shall not exceed 2H:1V.
- Between October 1 and April 30:

- An interceptor dike with gravel outlet and silt fence shall surround all topsoil.
- Within 2 days complete erosion control seeding, or covering stockpiles with clear plastic, or other mulching materials.
- Between May 1 and September 30:
  - An interceptor dike with gravel outlet and silt fence shall surround all topsoil if the stockpile will remain in place for a longer period of time than active construction grading.
  - Within 7 days complete erosion control seeding, or covering stockpiles with clear plastic, or other mulching materials.
- When native topsoil is to be stockpiled and reused the following should apply to ensure that the mycorrhizal bacterial, earthworms, and other beneficial organisms will not be destroyed:
  1. Re-install topsoil within 4 to 6 weeks.
  2. Do not allow the saturation of topsoil with water.
  3. Do not use plastic covering.

### ***Maintenance Standards***

- Inspect stockpiles regularly, especially after large storm events. Stabilize any areas that have eroded.
- Establish soil quality and depth toward the end of construction and once established, protect from compaction, such as from large machinery use, and from erosion.
- Plant and mulch soil after installation.
- Leave plant debris or its equivalent on the soil surface to replenish organic matter.
- Reduce and adjust, where possible, the use of irrigation, fertilizers, herbicides and pesticides, rather than continuing to implement formerly established practices.

# BMP C130: Surface Roughening

## *Purpose*

Surface roughening aids in the establishment of vegetative cover, reduces runoff velocity, increases infiltration, and provides for sediment trapping through the provision of a rough soil surface. Horizontal depressions are created by operating a tiller or other suitable equipment on the contour or by leaving slopes in a roughened condition by not fine grading them.

Use this BMP in conjunction with other BMPs such as seeding, mulching, or sodding.

## *Conditions for Use*

- All slopes steeper than 3H:1V and greater than 5 vertical feet require surface roughening to a depth of 2 to 4 inches prior to seeding..
- Areas that will not be stabilized immediately may be roughened to reduce runoff velocity until seeding takes place.
- Slopes with a stable rock face do not require roughening.
- Slopes where mowing is planned should not be excessively roughened.

## *Design and Installation Specifications*

There are different methods for achieving a roughened soil surface on a slope, and the selection of an appropriate method depends upon the type of slope. Roughening methods include stair-step grading, grooving, contour furrows, and tracking. See [Figure II-4.1.5 Surface Roughening by Tracking and Contour Furrows](#) for tracking and contour furrows. Factors to be considered in choosing a method are slope steepness, mowing requirements, and whether the slope is formed by cutting or filling.

- Disturbed areas that will not require mowing may be stair-step graded, grooved, or left rough after filling.
- Stair-step grading is particularly appropriate in soils containing large amounts of soft rock. Each "step" catches material that sloughs from above, and provides a level site where vegetation can become established. Stairs should be wide enough to work with standard earth moving equipment. Stair steps must be on contour or gullies will form on the slope.
- Areas that will be mowed (these areas should have slopes less steep than 3H:1V) may have small furrows left by disking, harrowing, raking, or seed-planting machinery operated on the contour.



- Graded areas with slopes steeper than 3H:1V but less than 2H:1V should be roughened before seeding. This can be accomplished in a variety of ways, including "track walking," or driving a crawler tractor up and down the slope, leaving a pattern of cleat imprints parallel to slope contours.
- Tracking is done by operating equipment up and down the slope to leave horizontal depressions in the soil.

### ***Maintenance Standards***

- Areas that are graded in this manner should be seeded as quickly as possible.
- Regular inspections should be made of the area. If rills appear, they should be re-graded and re-seeded immediately.

#### **Figure II-4.1.5 Surface Roughening by Tracking and Contour Furrows**



[2014 Figure II-4.1.5 pdf download](#)

---

*Washington State Department of Ecology*

[2012 Stormwater Management Manual for Western Washington, as Amended in December 2014 \(The 2014 SWMMWW\)](#)

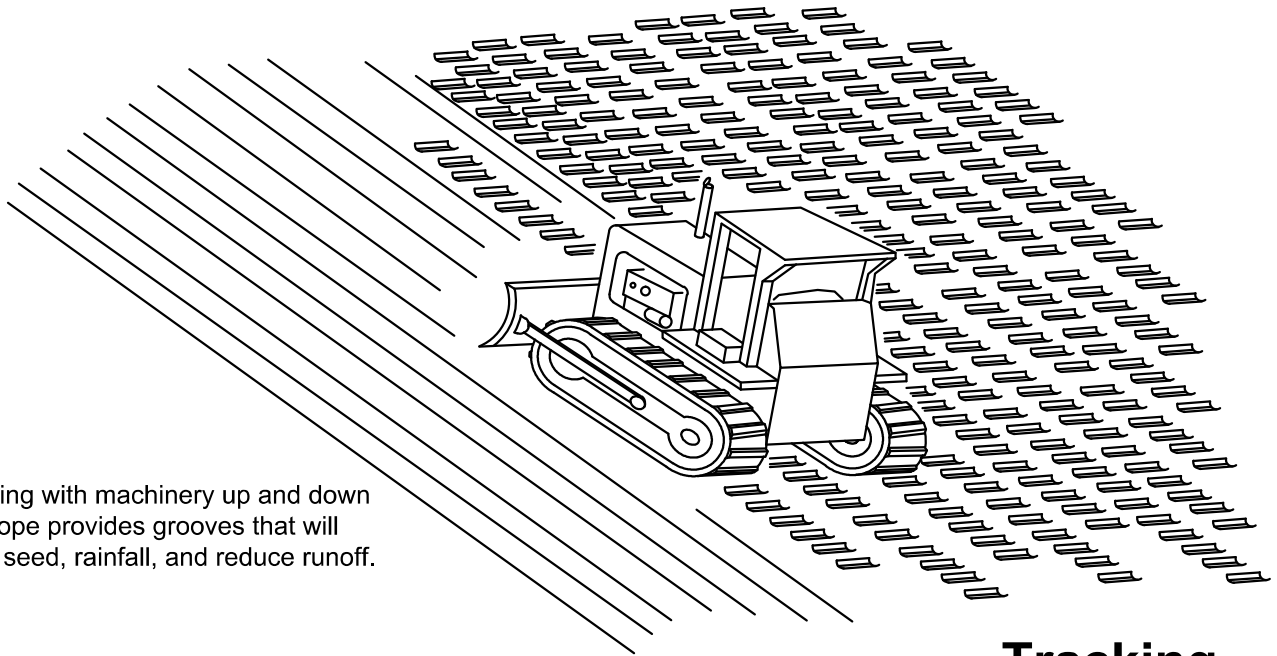

Tracking with machinery up and down the slope provides grooves that will catch seed, rainfall, and reduce runoff.

## Tracking

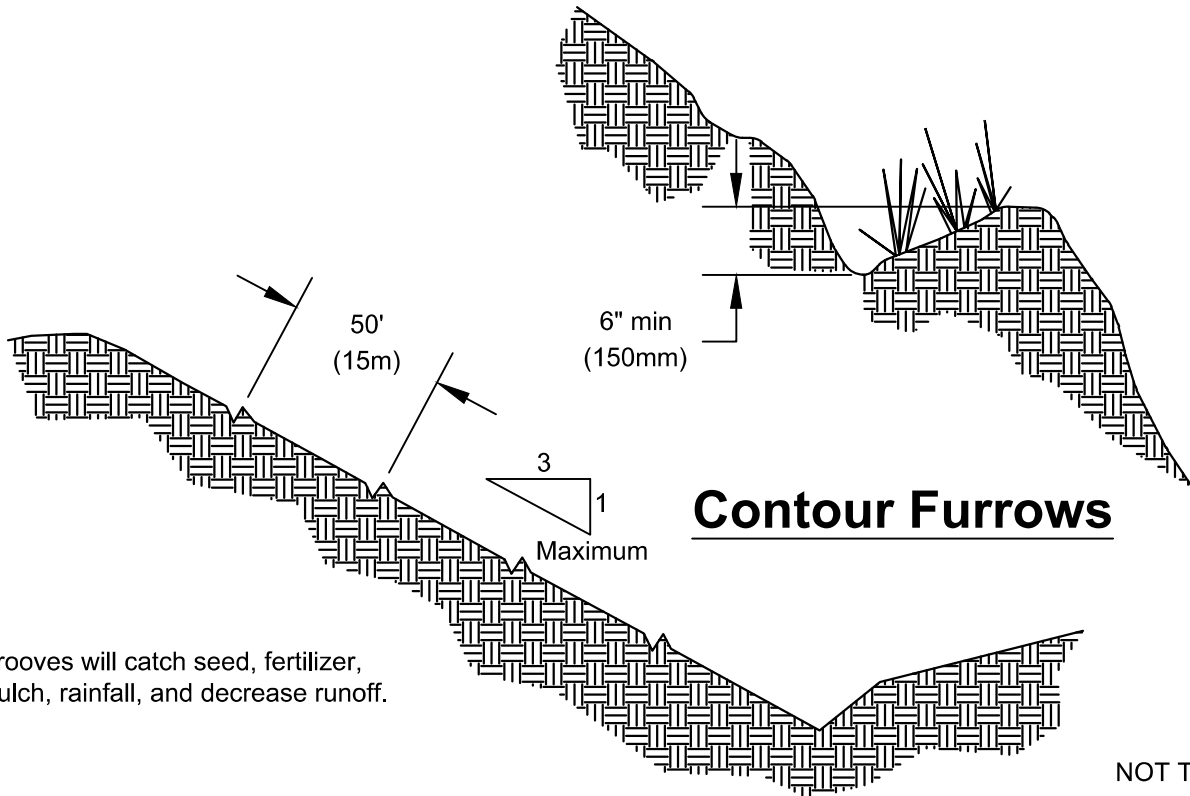

Grooves will catch seed, fertilizer, mulch, rainfall, and decrease runoff.

## Contour Furrows

NOT TO SCALE



DEPARTMENT OF  
**ECOLOGY**  
State of Washington

## Figure II-4.1.5 Surface Roughening by Tracking and Contour Furrows

Revised June 2015

Please see <http://www.ecy.wa.gov/copyright.html> for copyright notice including permissions, limitation of liability, and disclaimer.

# BMP C131: Gradient Terraces

## *Purpose*

Gradient terraces reduce erosion damage by intercepting surface runoff and conducting it to a stable outlet at a non-erosive velocity.

## *Conditions of Use*

- Gradient terraces normally are limited to denuded land having a water erosion problem. They should not be constructed on deep sands or on soils that are too stony, steep, or shallow to permit practical and economical installation and maintenance. Gradient terraces may be used only where suitable outlets are or will be made available. See [Figure II-4.1.6 Gradient Terraces](#) for gradient terraces.

## *Design and Installation Specifications*

- The maximum vertical spacing of gradient terraces should be determined by the following method:

$$VI = (0.8)s + y$$

Where:

VI = vertical interval in feet

s = land rise per 100 feet, expressed in feet

y = a soil and cover variable with values from 1.0 to 4.0

Values of “y” are influenced by soil erodibility and cover practices. The lower values are applicable to erosive soils where little to no residue is left on the surface. The higher value is applicable only to erosion-resistant soils where a large amount of residue (1½ tons of straw/acre equivalent) is on the surface.

- The minimum constructed cross-section should meet the design dimensions.
- The top of the constructed ridge should not be lower at any point than the design elevation plus the specified overfill for settlement. The opening at the outlet end of the terrace should have a cross section equal to that specified for the terrace channel.
- Channel grades may be either uniform or variable with a maximum grade of 0.6 feet per 100 feet length (0.6%). For short distances, terrace grades may be increased to improve alignment. The

channel velocity should not exceed that which is nonerosive for the soil type.

- All gradient terraces should have adequate outlets. Such an outlet may be a grassed waterway, vegetated area, or tile outlet. In all cases the outlet must convey runoff from the terrace or terrace system to a point where the outflow will not cause damage. Vegetative cover should be used in the outlet channel.
- The design elevation of the water surface of the terrace should not be lower than the design elevation of the water surface in the outlet at their junction, when both are operating at design flow.
- Vertical spacing determined by the above methods may be increased as much as 0.5 feet or 10 percent, whichever is greater, to provide better alignment or location, to avoid obstacles, to adjust for equipment size, or to reach a satisfactory outlet. The drainage area above the terrace should not exceed the area that would be drained by a terrace with normal spacing.
- The terrace should have enough capacity to handle the peak runoff expected from a 2-year, 24-hour design storm without overtopping.
- The terrace cross-section should be proportioned to fit the land slope. The ridge height should include a reasonable settlement factor. The ridge should have a minimum top width of 3 feet at the design height. The minimum cross-sectional area of the terrace channel should be 8 square feet for land slopes of 5 percent or less, 7 square feet for slopes from 5 to 8 percent, and 6 square feet for slopes steeper than 8 percent. The terrace can be constructed wide enough to be maintained using a small vehicle.

### ***Maintenance Standards***

- Maintenance should be performed as needed. Terraces should be inspected regularly; at least once a year, and after large storm events.

### **Figure II-4.1.6 Gradient Terraces**



[2014 Figure II-4.1.6 pdf download](#)

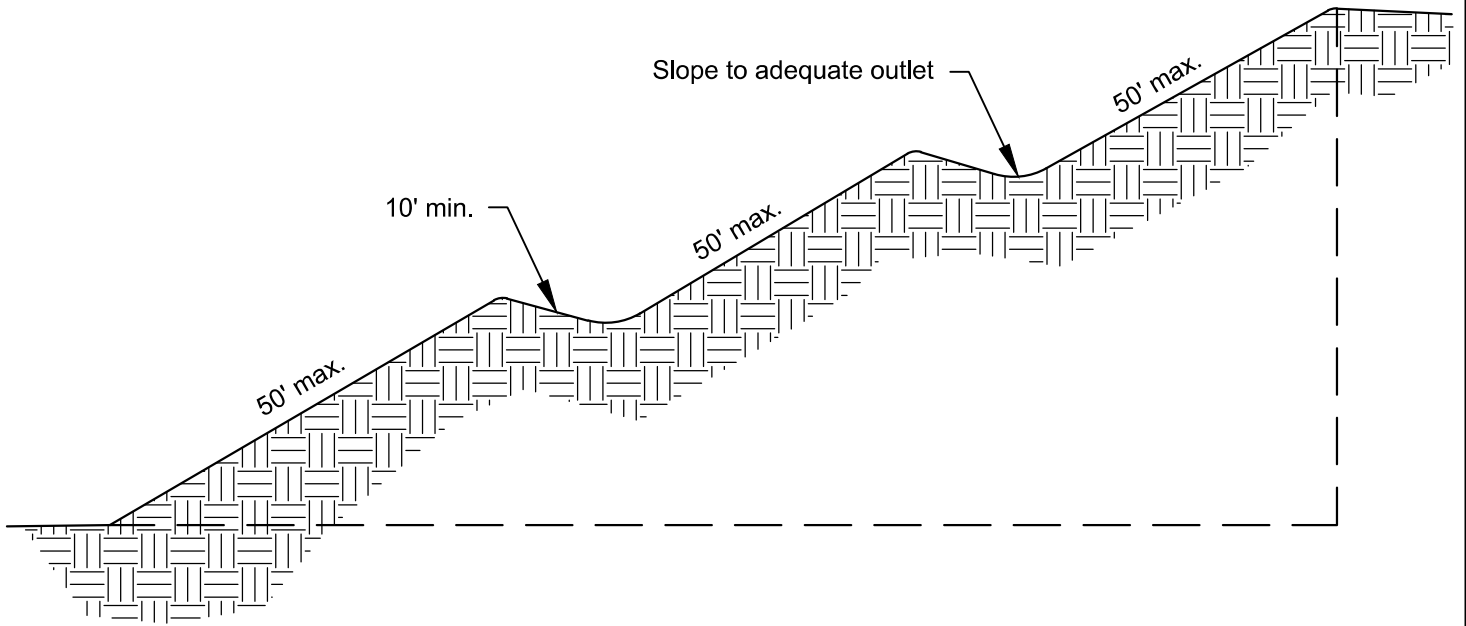

NOT TO SCALE



Figure II-4.1.6  
Gradient Terraces

Revised June 2015

Please see <http://www.ecy.wa.gov/copyright.html> for copyright notice including permissions, limitation of liability, and disclaimer.

## **BMP C140: Dust Control**

<i>Purpose</i>	Dust control prevents wind transport of dust from disturbed soil surfaces onto roadways, drainage ways, and surface waters.
<i>Conditions of Use</i>	<ul style="list-style-type: none"><li>• In areas (including roadways) subject to surface and air movement of dust where on-site and off-site impacts to roadways, drainage ways, or surface waters are likely.</li></ul>
<i>Design and Installation Specifications</i>	<ul style="list-style-type: none"><li>• Vegetate or mulch areas that will not receive vehicle traffic. In areas where planting, mulching, or paving is impractical, apply gravel or landscaping rock.</li><li>• Limit dust generation by clearing only those areas where immediate activity will take place, leaving the remaining area(s) in the original condition, if stable. Maintain the original ground cover as long as practical.</li><li>• Construct natural or artificial windbreaks or windscreens. These may be designed as enclosures for small dust sources.</li><li>• Sprinkle the site with water until surface is wet. Repeat as needed. To prevent carryout of mud onto street, refer to Stabilized Construction Entrance (BMP C105).</li><li>• Irrigation water can be used for dust control. Irrigation systems should be installed as a first step on sites where dust control is a concern.</li><li>• Spray exposed soil areas with a dust palliative, following the manufacturer's instructions and cautions regarding handling and application. Used oil is prohibited from use as a dust suppressant. Local governments may approve other dust palliatives such as calcium chloride or PAM.</li><li>• PAM (BMP C126) added to water at a rate of 0.5 lbs. per 1,000 gallons of water per acre and applied from a water truck is more effective than water alone. This is due to the increased infiltration of water into the soil and reduced evaporation. In addition, small soil particles are bonded together and are not as easily transported by wind. Adding PAM may actually reduce the quantity of water needed for dust control, especially in eastern Washington. Since the wholesale cost of PAM is about \$ 4.00 per pound, this is an extremely cost-effective dust control method.</li></ul> <p>Techniques that can be used for unpaved roads and lots include:</p> <ul style="list-style-type: none"><li>• Lower speed limits. High vehicle speed increases the amount of dust stirred up from unpaved roads and lots.</li><li>• Upgrade the road surface strength by improving particle size, shape, and mineral types that make up the surface and base materials.</li></ul>

- Add surface gravel to reduce the source of dust emission. Limit the amount of fine particles (those smaller than .075 mm) to 10 to 20 percent.
- Use geotextile fabrics to increase the strength of new roads or roads undergoing reconstruction.
- Encourage the use of alternate, paved routes, if available.
- Restrict use by tracked vehicles and heavy trucks to prevent damage to road surface and base.
- Apply chemical dust suppressants using the admix method, blending the product with the top few inches of surface material. Suppressants may also be applied as surface treatments.
- Pave unpaved permanent roads and other trafficked areas.
- Use vacuum street sweepers.
- Remove mud and other dirt promptly so it does not dry and then turn into dust.
- Limit dust-causing work on windy days.
- Contact your local Air Pollution Control Authority for guidance and training on other dust control measures. Compliance with the local Air Pollution Control Authority constitutes compliance with this BMP.

***Maintenance Standards***

Respray area as necessary to keep dust to a minimum.

## **BMP C154: Concrete Washout Area**

### ***Purpose***

Prevent or reduce the discharge of pollutants from concrete waste to stormwater by conducting washout off-site, or performing on-site washout in a designated area.

### ***Conditions of Use***

Concrete washout areas are implemented on construction projects where:

- Concrete is used as a construction material
- It is not possible to dispose of all concrete wastewater and washout off-site (ready mix plant, etc.).
- Concrete truck drums are washed on-site.

Note that auxiliary concrete truck components (e.g. chutes and hoses) and small concrete handling equipment (e.g. hand tools, screeds, shovels, rakes, floats, trowels, and wheelbarrows) may be washed into formed areas awaiting concrete pour.

At no time shall concrete be washed off into the footprint of an area where an infiltration feature will be installed.

### ***Design and Installation Specifications***

#### **Implementation**

- Perform washout of concrete truck drums at an approved off-site location or in designated concrete washout areas only.
- Do not wash out concrete onto non-formed areas, or into storm drains, open ditches, streets, or streams.
- Wash equipment difficult to move, such as concrete paving machines, in areas that do not directly drain to natural or constructed stormwater conveyance or potential infiltration areas.
- Do not allow excess concrete to be dumped on-site, except in designated concrete washout areas as allowed above.
- Concrete washout areas may be prefabricated concrete washout containers, or self-installed structures (above-grade or below-grade).
- Prefabricated containers are most resistant to damage and protect against spills and leaks. Companies may offer delivery service and provide regular maintenance and disposal of solid and liquid waste.



- If self-installed concrete washout areas are used, below-grade structures are preferred over above-grade structures because they are less prone to spills and leaks.
- Self-installed above-grade structures should only be used if excavation is not practical.
- Concrete washout areas shall be constructed and maintained in sufficient quantity and size to contain all liquid and concrete waste generated by washout operations.

## **Education**

- Discuss the concrete management techniques described in this BMP with the ready-mix concrete supplier before any deliveries are made.
- Educate employees and subcontractors on the concrete waste management techniques described in this BMP.
- Arrange for the contractor's superintendent or Certified Erosion and Sediment Control Lead (CESCL) to oversee and enforce concrete waste management procedures.
- A sign should be installed adjacent to each concrete washout area to inform concrete equipment operators to utilize the proper facilities.

## **Contracts**

Incorporate requirements for concrete waste management into concrete supplier and subcontractor agreements.

## **Location and Placement**

- Locate concrete washout areas at least 50 feet from sensitive areas such as storm drains, open ditches, water bodies, or wetlands.
- Allow convenient access to the concrete washout area for concrete trucks, preferably near the area where the concrete is being poured.
- If trucks need to leave a paved area to access the concrete washout area, prevent track-out with a pad of rock or quarry spalls (see [BMP C105: Stabilized Construction Access](#)). These areas should be far enough away from other construction traffic to reduce the likelihood of accidental damage and spills.
- The number of concrete washout areas you install should depend on the expected demand for storage capacity.
- On large sites with extensive concrete work, concrete washout areas should be placed in multiple locations for ease of use by concrete truck drivers.

## **Concrete Truck Washout Procedures**

- Washout of concrete truck drums shall be performed in designated concrete washout areas only.

- Concrete washout from concrete pumper bins can be washed into concrete pumper trucks and discharged into designated concrete washout areas or properly disposed of off-site.

### **Concrete Washout Area Installation**

- Concrete washout areas should be constructed as shown in the figures below, with a recommended minimum length and minimum width of 10 ft, but with sufficient quantity and volume to contain all liquid and concrete waste generated by washout operations.
- Plastic lining material should be a minimum of 10 mil polyethylene sheeting and should be free of holes, tears, or other defects that compromise the impermeability of the material.
- Lath and flagging should be commercial type.
- Liner seams shall be installed in accordance with manufacturers' recommendations.
- Soil base shall be prepared free of rocks or other debris that may cause tears or holes in the plastic lining material.

### ***Maintenance Standards***

#### **Inspection and Maintenance**

- Inspect and verify that concrete washout areas are in place prior to the commencement of concrete work.
- Once concrete wastes are washed into the designated washout area and allowed to harden, the concrete should be broken up, removed, and disposed of per applicable solid waste regulations. Dispose of hardened concrete on a regular basis.
- During periods of concrete work, inspect the concrete washout areas daily to verify continued performance.
  - Check overall condition and performance.
  - Check remaining capacity (% full).
  - If using self-installed concrete washout areas, verify plastic liners are intact and sidewalls are not damaged.
  - If using prefabricated containers, check for leaks.
- Maintain the concrete washout areas to provide adequate holding capacity with a minimum freeboard of 12 inches.
- Concrete washout areas must be cleaned, or new concrete washout areas must be constructed and ready for use once the concrete washout area is 75% full.
- If the concrete washout area is nearing capacity, vacuum and dispose of the waste material in an approved manner.

- Do not discharge liquid or slurry to waterways, storm drains or directly onto ground.
  - Do not discharge to the sanitary sewer without local approval.
  - Place a secure, non-collapsing, non-water collecting cover over the concrete washout area prior to predicted wet weather to prevent accumulation and overflow of precipitation.
  - Remove and dispose of hardened concrete and return the structure to a functional condition. Concrete may be reused on-site or hauled away for disposal or recycling.
- When you remove materials from a self-installed concrete washout area, build a new structure; or, if the previous structure is still intact, inspect for signs of weakening or damage, and make any necessary repairs. Re-line the structure with new plastic after each cleaning.

### **Removal of Concrete Washout Areas**

- When concrete washout areas are no longer required for the work, the hardened concrete, slurries and liquids shall be removed and properly disposed of.
- Materials used to construct concrete washout areas shall be removed from the site of the work and disposed of or recycled.
- Holes, depressions or other ground disturbance caused by the removal of the concrete washout areas shall be backfilled, repaired, and stabilized to prevent erosion.

**Figure II-3.7: Concrete Washout Area with Wood Planks**

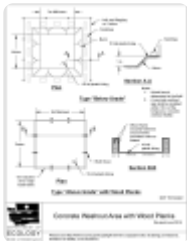

[pdf download](#)

**Figure II-3.8: Concrete Washout Area with Straw Bales**

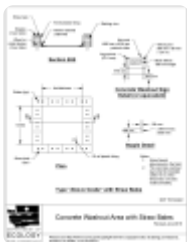

[pdf download](#)

**Figure II-3.9: Prefabricated Concrete Washout Container w/Ramp**



[pdf download](#)

---

**Washington State Department of Ecology**

*2019 Stormwater Management Manual for Western Washington (2019 SWMMWW)*

Publication No.19-10-021

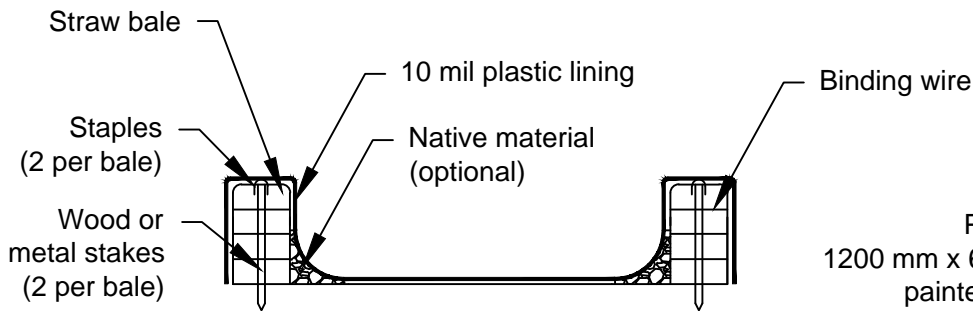

**Section B-B**

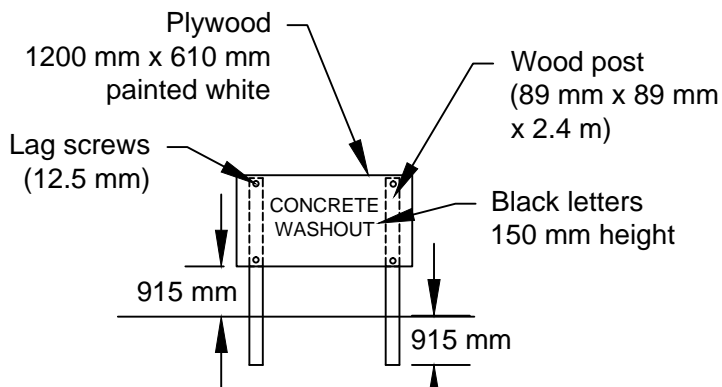

**Concrete Washout Sign Detail (or equivalent)**

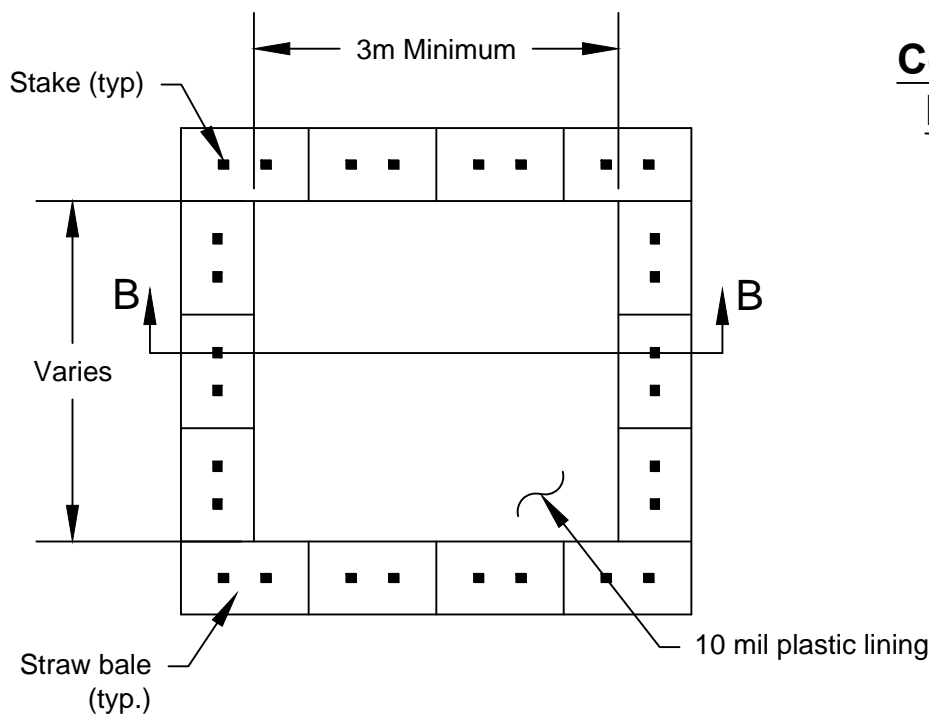

**Plan**

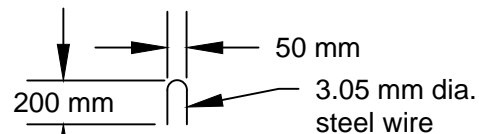

**Staple Detail**

**Notes:**

1. Actual layout determined in the field.
2. The concrete washout sign shall be installed within 10 m of the temporary concrete washout facility.

**Type "Above Grade" with Straw Bales**

NOT TO SCALE



DEPARTMENT OF  
**ECOLOGY**  
State of Washington

**Concrete Washout Area with Straw Bales**

Revised June 2016

Please see <http://www.ecy.wa.gov/copyright.html> for copyright notice including permissions, limitation of liability, and disclaimer.

## **BMP C160: Certified Erosion and Sediment Control Lead**

### ***Purpose***

The project proponent designates at least one person as the responsible representative in charge of erosion and sediment control (ESC), and water quality protection. The designated person shall be responsible for ensuring compliance with all local, state, and federal erosion and sediment control and water quality requirements. Construction sites one acre or larger that discharge to waters of the State must designate a Certified Erosion and Sediment Control Lead (CESCL) as the responsible representative.

### ***Conditions of Use***

A CESCL shall be made available on projects one acre or larger that discharge stormwater to surface waters of the state. Sites less than one acre may have a person without CESCL certification conduct inspections.

The CESCL shall:

- Have a current certificate proving attendance in an erosion and sediment control training course that meets the minimum ESC training and certification requirements established by Ecology.

Ecology has provided the minimum requirements for CESCL course training, as well as a list of ESC training and certification providers at:

<https://ecology.wa.gov/Regulations-Permits/Permits-certifications/Certified-erosion-sediment-control>

**OR**

- Be a Certified Professional in Erosion and Sediment Control (CPESC). For additional information go to:

<http://www.envirocertintl.org/cpesc/>

### ***Specifications***

- CESCL certification shall remain valid for three years.
- The CESCL shall have authority to act on behalf of the contractor or project proponent and shall be available, or on-call, 24 hours per day throughout the period of construction.
- The Construction SWPPP shall include the name, telephone number, fax number, and address of the designated CESCL. See [II-2 Construction Stormwater Pollution Prevention Plans \(Construction SWPPPs\)](#).
- A CESCL may provide inspection and compliance services for multiple construction projects in the same geographic region, but must be on site whenever earthwork activities are occurring that could generate

release of turbid water.

- Duties and responsibilities of the CESCL shall include, but are not limited to the following:
  - Maintaining a permit file on site at all times which includes the Construction SWPPP and any associated permits and plans.
  - Directing BMP installation, inspection, maintenance, modification, and removal.
  - Updating all project drawings and the Construction SWPPP with changes made.
  - Completing any sampling requirements including reporting results using electronic Discharge Monitoring Reports (WebDMR).
  - Facilitate, participate in, and take corrective actions resulting from inspections performed by outside agencies or the owner.
  - Keeping daily logs, and inspection reports. Inspection reports should include:
    - Inspection date/time.
    - Weather information; general conditions during inspection and approximate amount of precipitation since the last inspection.
    - Visual monitoring results, including a description of discharged stormwater. The presence of suspended sediment, turbid water, discoloration, and oil sheen shall be noted, as applicable.
    - Any water quality monitoring performed during inspection.
    - General comments and notes, including a brief description of any BMP repairs, maintenance or installations made as a result of the inspection.
    - A summary or list of all BMPs implemented, including observations of all erosion/sediment control structures or practices. The following shall be noted:
      1. Locations of BMPs inspected.
      2. Locations of BMPs that need maintenance.
      3. Locations of BMPs that failed to operate as designed or intended.
      4. Locations of where additional or different BMPs are required.

---

**Washington State Department of Ecology**

*2019 Stormwater Management Manual for Western Washington (2019 SWMMWW)*

Publication No.19-10-021

# **BMP C200: Interceptor Dike and Swale**

## ***Purpose***

Provide a ridge of compacted soil, or a ridge with an upslope swale, at the top or base of a disturbed slope or along the perimeter of a disturbed construction area to convey stormwater. Use the dike and/or swale to intercept the runoff from unprotected areas and direct it to areas where erosion can be controlled. This can prevent storm runoff from entering the work area or sediment-laden runoff from leaving the construction site.

## ***Conditions of Use***

Where the runoff from an exposed site or disturbed slope must be conveyed to an erosion control facility which can safely convey the stormwater.

- Locate upslope of a construction site to prevent runoff from entering disturbed area.
- When placed horizontally across a disturbed slope, it reduces the amount and velocity of runoff flowing down the slope.
- Locate downslope to collect runoff from a disturbed area and direct water to a sediment basin.

## ***Design and Installation Specifications***

- Dike and/or swale and channel must be stabilized with temporary or permanent vegetation or other channel protection during construction.
- Channel requires a positive grade for drainage; steeper grades require channel protection and check dams.
- Review construction for areas where overtopping may occur.
- Can be used at top of new fill before vegetation is established.
- May be used as a permanent diversion channel to carry the runoff.
- Sub-basin tributary area should be one acre or less.
- Design capacity for the peak volumetric flow rate calculated using a 10-minute time step from a 10-year, 24-hour storm, assuming a Type 1A rainfall distribution, for temporary facilities. Alternatively, use 1.6 times the 10-year, 1-hour flow indicated by an approved continuous runoff model. For



facilities that will also serve on a permanent basis, consult the local government's drainage requirements.

**Interceptor dikes** shall meet the following criteria:

- Top Width: 2 feet minimum.
- Height: 1.5 feet minimum on berm.
- Side Slope: 2H:1V or flatter.
- Grade: Depends on topography, however, dike system minimum is 0.5%, and maximum is 1%.
- Compaction: Minimum of 90 percent ASTM D698 standard proctor.
- Horizontal Spacing of Interceptor Dikes:

Average Slope	Slope Percent	Flowpath Length
20H:1V or less	3-5%	300 feet
(10 to 20)H:1V	5-10%	200 feet
(4 to 10)H:1V	10-25%	100 feet
(2 to 4)H:1V	25-50%	50 feet

- Stabilization: depends on velocity and reach
- Slopes <5%: Seed and mulch applied within 5 days of dike construction (see [BMP C121: Mulching](#)).
- Slopes 5 - 40%: Dependent on runoff velocities and dike materials. Stabilization should be done immediately using either sod or riprap or other measures to avoid erosion.
- The upslope side of the dike shall provide positive drainage to the dike outlet. No erosion shall occur at the outlet. Provide energy dissipation measures as necessary. Sediment-laden runoff must be released through a sediment trapping facility.
- Minimize construction traffic over temporary dikes. Use temporary cross culverts for channel crossing.

**Interceptor swales** shall meet the following criteria:

- Bottom Width: 2 feet minimum; the cross-section bottom shall be level.
- Depth: 1-foot minimum.
- Side Slope: 2H:1V or flatter.
- Grade: Maximum 5 percent, with positive drainage to a suitable outlet (such as a sediment pond).
- Stabilization: Seed as per [BMP C120: Temporary and Permanent Seeding](#), or [BMP C202: Channel Lining](#), 12 inches thick riprap pressed into the bank and extending at least 8 inches vertical from the bottom.

Inspect diversion dikes and interceptor swales once a week and after every rainfall. Immediately remove sediment from the flow area.

Damage caused by construction traffic or other activity must be repaired before the end of each working day.

Check outlets and make timely repairs as needed to avoid gully formation. When the area below the temporary diversion dike is permanently stabilized, remove the dike and fill and stabilize the channel to blend with the natural surface.

---

*Washington State Department of Ecology*

[2012 Stormwater Management Manual for Western Washington, as Amended in December 2014 \(The 2014 SWMMWW\)](#)

## **BMP C202: Riprap Channel Lining**

### ***Purpose***

To protect channels by providing a channel liner using riprap.

### ***Conditions of Use***

Use this BMP when natural soils or vegetated stabilized soils in a channel are not adequate to prevent channel erosion.

Use this BMP when a permanent ditch or pipe system is to be installed and a temporary measure is needed.

An alternative to riprap channel lining is [BMP C122: Nets and Blankets](#).

The Federal Highway Administration recommends not using geotextile liners whenever the slope exceeds 10 percent or the shear stress exceeds 8 lbs/ft<sup>2</sup>.

### ***Design and Installation Specifications***

- Since riprap is typically used where erosion potential is high, construction must be sequenced so that the riprap is put in place with the minimum possible delay.
- Disturb areas awaiting riprap only when final preparation and placement of the riprap can follow immediately behind the initial disturbance. Where riprap is used for outlet protection, the riprap should be placed before or in conjunction with the construction of the pipe or channel so that it is in place when the pipe or channel begins to operate.
- The designer, after determining the riprap size that will be stable under the flow conditions, shall consider that size to be a minimum size and then, based on riprap gradations actually available in the area, select the size or sizes that equal or exceed the minimum size. The possibility of drainage structure damage by others shall be considered in selecting a riprap size, especially if there is nearby water or a gully in which to toss the stones.
- Stone for riprap shall consist of field stone or quarry stone of approximately rectangular shape. The stone shall be hard and angular and of such quality that it will not disintegrate on exposure to water or weathering and it shall be suitable in all respects for the purpose intended. See Section 9-13 of WSDOT's *Standard Specifications for Road, Bridge, and Municipal Construction* ([WSDOT, 2016](#)).
- A lining of engineering filter fabric (geotextile) shall be placed between the riprap and the underlying soil surface to prevent soil movement into or through the riprap. The geotextile should be keyed in at the top of the bank.

- Filter fabric shall not be used on slopes greater than 1.5H:1V as slippage may occur. It should be used in conjunction with a layer of coarse aggregate (granular filter blanket) when the riprap to be placed is 12 inches and larger.

## ***Maintenance Standards***

Replace riprap as needed.

---

**Washington State Department of Ecology**

*2019 Stormwater Management Manual for Western Washington (2019 SWMMWW)*

Publication No.19-10-021

## **BMP C204: Pipe Slope Drains**

### ***Purpose***

The purpose of pipe slope drains is to prevent gullies, channel erosion, and saturation of slide-prone soils by using a pipe to convey stormwater away from or over bare soil.

### ***Conditions of Use***

Pipe slope drains should be used when a temporary or permanent stormwater conveyance is needed to move water down a steep slope to avoid erosion.

Pipe slope drains should be used at bridge ends to collect runoff and convey it to the base of the fill slopes along the bridge approaches. Another use on road projects is to collect runoff from pavement in a pipe slope drain and convey it away from side slopes.

Temporary installations of pipe slope drains can be useful because there is generally a time lag between having the first lift of asphalt installed and the curbs, gutters, and permanent drainage installed. Used in conjunction with sand bags, or other temporary diversion devices, these will prevent massive amounts of sediment from leaving a project.

Pipe slope drains can serve the following purposes:

- Connection to new catch basins and temporarily use until permanent piping is installed.
- Drainage of water collected from aquifers exposed on cut slopes and conveyance of water to the base of the slope.
- Collection of clean runoff from plastic sheeting and routing the runoff away from exposed soil.
- Installation in conjunction with silt fence to drain collected water to a controlled area.
- Diversion of small seasonal streams away from construction. They have been used successfully on culvert replacement and extension jobs. Large flex pipe can be used on larger streams during culvert removal, repair, or replacement.
- Connection to existing downspouts and roof drains and diversion of water away from work areas during building renovation, demolition, and construction projects.

There are several commercially available collectors that attach to the pipe inlet and help prevent erosion at the inlet.

### ***Design and Installation Specifications***

See [Figure II-3.13: Pipe Slope Drain](#).

Size the pipe to convey the projected flow. The capacity for temporary drains shall be sufficient to handle flows calculated by one of the following methods:

- Single Event Hydrograph Method: The peak volumetric flow rate calculated using a 10-minute time step from a Type 1A, 10-year, 24-hour frequency storm for the worst-case land cover condition.

OR

- Continuous Simulation Method: The 10-year peak flow rate, as determined by an approved continuous runoff model with a 15-minute time step for the worst-case land cover condition.

Worst-case land cover conditions (i.e., producing the most runoff) should be used for analysis (in most cases, this would be the land cover conditions just prior to final landscaping).

Consult local drainage requirements for sizing permanent pipe slope drains.

- Use care in clearing vegetated slopes for installation.
- Re-establish cover immediately on areas disturbed by installation.
- Use temporary drains on new cut or fill slopes.
- Use [BMP C200: Interceptor Dike and Swale](#) to collect water at the top of the slope.
- Ensure that the entrance area is stable and large enough to direct flow into the pipe.
- Piping of water through the berm at the entrance area is a common failure mode.
- The entrance shall consist of a standard flared end section for culverts 12 inches and larger with a minimum 6-inch metal toe plate to prevent runoff from undercutting the pipe inlet. The slope of the entrance shall be at least 3 percent. Sand bags may also be used at pipe entrances as a temporary measure.
- The soil around and under the pipe and entrance section shall be thoroughly compacted to prevent undercutting.
- The flared inlet section shall be securely connected to the slope drain and have watertight connecting bands.
- Slope drain sections shall be securely fastened together, fused or have gasketed watertight fittings, and shall be securely anchored into the soil.
- Thrust blocks should be installed anytime 90 degree bends are utilized. Depending on size of pipe and flow, these can be constructed with sand bags, straw bales staked in place, “t” posts and wire, or ecology blocks.
- Pipe needs to be secured along its full length to prevent movement. This can be done with steel “t” posts and wire. Install a post on each side of the pipe and wire the pipe to them. This should be done every 10-20 feet of pipe length or so, depending on the size of the pipe and quantity of water to divert.

- [BMP C200: Interceptor Dike and Swale](#) shall be used to direct runoff into a pipe slope drain. The height of the dike shall be at least 1 foot higher at all points than the top of the inlet pipe.
- The area below the outlet must be stabilized. See [BMP C209: Outlet Protection](#).
- If the pipe slope drain is conveying sediment-laden water, direct all flows into a sediment trapping facility.
- Materials specifications for any permanent piped system shall be set by the local government.

## **Maintenance Standards**

Check inlet and outlet points regularly, especially after storms.

- The inlet should be free of undercutting, and no water should be going around the point of entry. If there are problems, the headwall should be reinforced with compacted earth or sand bags.
- The outlet point should be free of erosion and installed with appropriate outlet protection.

For permanent installations, inspect the pipe periodically for vandalism and physical distress such as slides and wind-throw. Clean the pipe and outlet structure at the completion of construction.

Normally the pipe slope is so steep that clogging is not a problem with smooth wall pipe, however, debris may become lodged in the pipe.

**Figure II-3.13: Pipe Slope Drain**

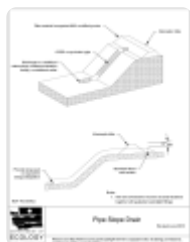

[pdf download](#)

---

**Washington State Department of Ecology**

*2019 Stormwater Management Manual for Western Washington (2019 SWMMWW)*

Publication No.19-10-021

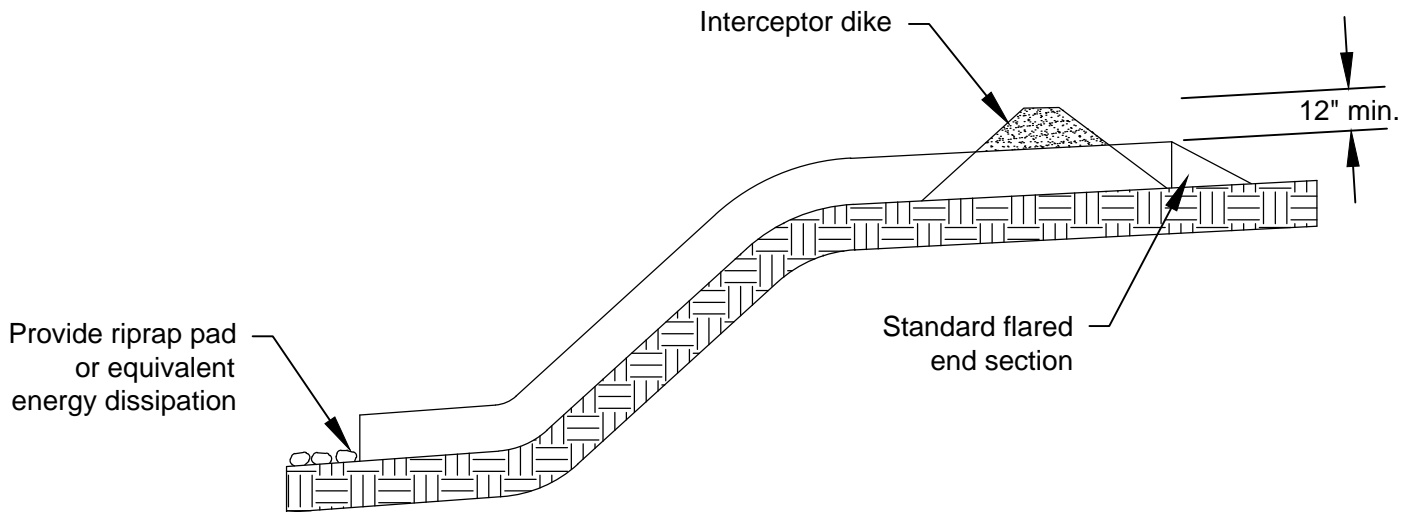
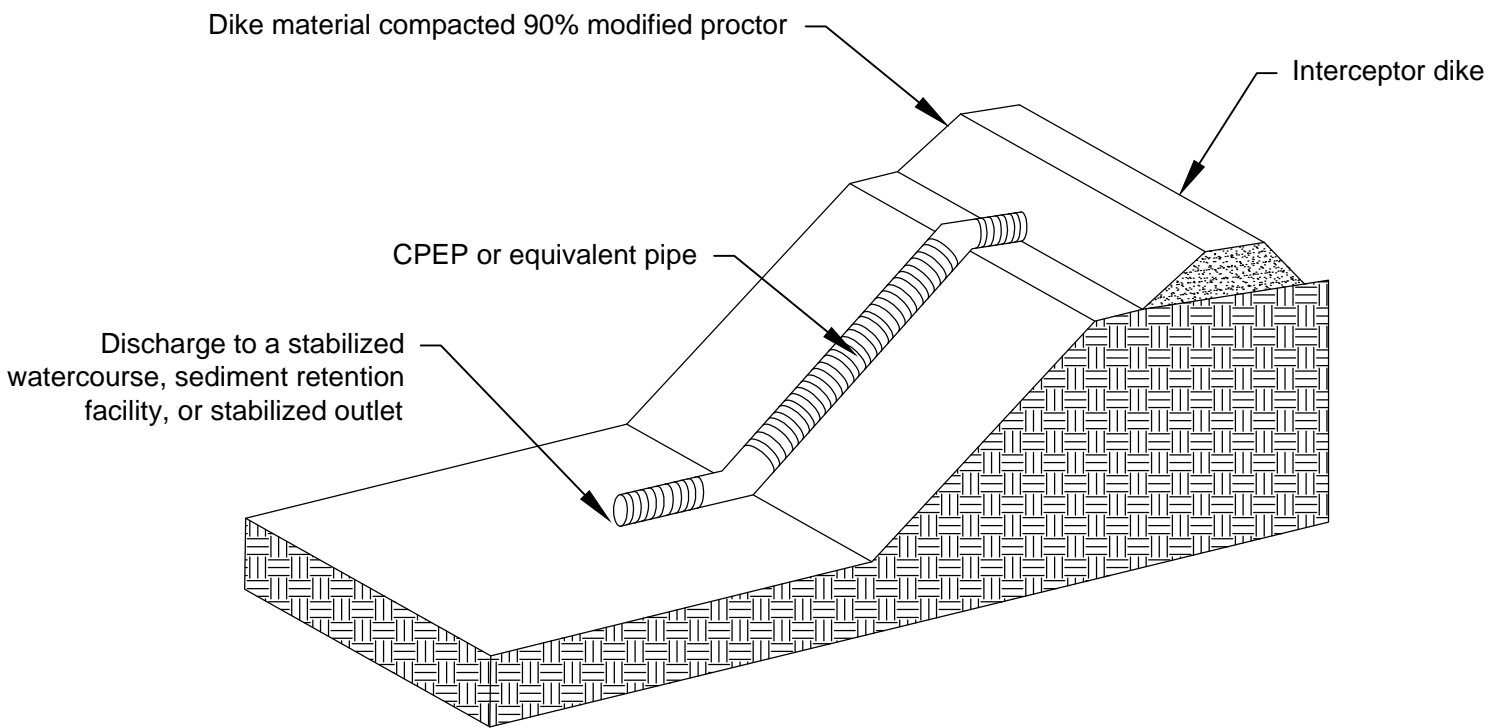

Notes:

1. Inlet and all sections must be securely fastened together with gasketed watertight fittings

NOT TO SCALE

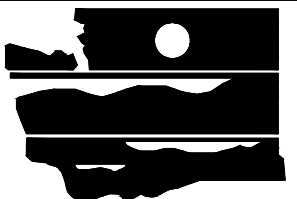

DEPARTMENT OF  
**ECOLOGY**  
State of Washington

## Pipe Slope Drain

Revised June 2016

Please see <http://www.ecy.wa.gov/copyright.html> for copyright notice including permissions, limitation of liability, and disclaimer.



# BMP C205: Subsurface Drains

## *Purpose*

To intercept, collect, and convey ground water to a satisfactory outlet, using a perforated pipe or conduit below the ground surface. Subsurface drains are also known as “french drains.” The perforated pipe provides a dewatering mechanism to drain excessively wet soils, provide a stable base for construction, improve stability of structures with shallow foundations, or to reduce hydrostatic pressure to improve slope stability.

## *Conditions of Use*

Use when excessive water must be removed from the soil. The soil permeability, depth to water table and impervious layers are all factors which may govern the use of subsurface drains.

## *Design and Installation Specifications*

**Relief drains** are used either to lower the water table in large, relatively flat areas, improve the growth of vegetation, or to remove surface water.

Relief drains are installed along a slope and drain in the direction of the slope.

They can be installed in a grid pattern, a herringbone pattern, or a random pattern.

- **Interceptor drains** are used to remove excess ground water from a slope, stabilize steep slopes, and lower the water table immediately below a slope to prevent the soil from becoming saturated.

Interceptor drains are installed perpendicular to a slope and drain to the side of the slope.

They usually consist of a single pipe or series of single pipes instead of a patterned layout.

- **Depth and spacing of interceptor drains** - The depth of an interceptor drain is determined primarily by the depth to which the water table is to be lowered or the depth to a confining layer. For practical reasons, the maximum depth is usually limited to 6 feet, with a minimum cover of 2 feet to protect the conduit.
- The soil should have depth and sufficient permeability to permit installation of an effective drainage system at a depth of 2 to 6 feet.
- An adequate outlet for the drainage system must be available either by gravity or by pumping.

- The quantity and quality of discharge needs to be accounted for in the receiving stream (additional detention may be required).
- This standard does not apply to subsurface drains for building foundations or deep excavations.
- The capacity of an interceptor drain is determined by calculating the maximum rate of ground water flow to be intercepted. Therefore, it is good practice to make complete subsurface investigations, including hydraulic conductivity of the soil, before designing a subsurface drainage system.
- **Size of drain** - Size subsurface drains to carry the required capacity without pressure flow. Minimum diameter for a subsurface drain is 4 inches.
- The minimum velocity required to prevent silting is 1.4 ft./sec. The line shall be graded to achieve this velocity at a minimum. The maximum allowable velocity using a sand-gravel filter or envelope is 9 ft/sec.
- Filter material and fabric shall be used around all drains for proper bedding and filtration of fine materials. Envelopes and filters should surround the drain to a minimum of 3-inch thickness.
- The outlet of the subsurface drain shall empty into a sediment pond through a catch basin. If free of sediment, it can then empty into a receiving channel, swale, or stable vegetated area adequately protected from erosion and undermining.
- The trench shall be constructed on a continuous grade with no reverse grades or low spots.
- Soft or yielding soils under the drain shall be stabilized with gravel or other suitable material.
- Backfilling shall be done immediately after placement of the pipe. No sections of pipe shall remain uncovered overnight or during a rainstorm. Backfill material shall be placed in the trench in such a manner that the drain pipe is not displaced or damaged.
- Do not install permanent drains near trees to avoid the tree roots that tend to clog the line. Use solid pipe with watertight connections where it is necessary to pass a subsurface drainage system through a stand of trees.
- **Outlet** - Ensure that the outlet of a drain empties into a channel or other watercourse above the normal water level.
- Secure an animal guard to the outlet end of the pipe to keep out rodents.
- Use outlet pipe of corrugated metal, cast iron, or heavy-duty plastic without perforations and at least 10 feet long. Do not use an envelope or filter material around the outlet pipe, and bury at

least two-thirds of the pipe length.

- When outlet velocities exceed those allowable for the receiving stream, outlet protection must be provided.

### ***Maintenance Standards***

Subsurface drains shall be checked periodically to ensure that they are free-flowing and not clogged with sediment or roots.

- The outlet shall be kept clean and free of debris.
- Surface inlets shall be kept open and free of sediment and other debris.
- Trees located too close to a subsurface drain often clog the system with their roots. If a drain becomes clogged, relocate the drain or remove the trees as a last resort. Drain placement should be planned to minimize this problem.
- Where drains are crossed by heavy vehicles, the line shall be checked to ensure that it is not crushed.

---

*Washington State Department of Ecology*

[2012 Stormwater Management Manual for Western Washington, as Amended in December 2014 \(The 2014 SWMMWW\)](#)

# BMP C207: Check Dams

## *Purpose*

Construction of small dams across a swale or ditch reduces the velocity of concentrated flow and dissipates energy at the check dam.

## *Conditions of Use*

Where temporary channels or permanent channels are not yet vegetated, channel lining is infeasible, and/or velocity checks are required.

- Check dams may not be placed in streams unless approved by the State Department of Fish and Wildlife. Check dams may not be placed in wetlands without approval from a permitting agency.
- Do not place check dams below the expected backwater from any salmonid bearing water between October 1 and May 31 to ensure that there is no loss of high flow refuge habitat for overwintering juvenile salmonids and emergent salmonid fry.
- Construct rock check dams from appropriately sized rock. The rock used must be large enough to stay in place given the expected design flow through the channel. The rock must be placed by hand or by mechanical means (no dumping of rock to form dam) to achieve complete coverage of the ditch or swale and to ensure that the center of the dam is lower than the edges.
- Check dams may also be constructed of either rock or pea-gravel filled bags. Numerous new products are also available for this purpose. They tend to be re-usable, quick and easy to install, effective, and cost efficient.
- Place check dams perpendicular to the flow of water.
- The dam should form a triangle when viewed from the side. This prevents undercutting as water flows over the face of the dam rather than falling directly onto the ditch bottom.
- Before installing check dams impound and bypass upstream water flow away from the work area. Options for bypassing include pumps, siphons, or temporary channels.
- Check dams in association with sumps work more effectively at slowing flow and retaining sediment than just a check dam alone. A deep sump should be provided immediately upstream of the check dam.

- In some cases, if carefully located and designed, check dams can remain as permanent installations with very minor regrading. They may be left as either spillways, in which case accumulated sediment would be graded and seeded, or as check dams to prevent further sediment from leaving the site.
- The maximum spacing between the dams shall be such that the toe of the upstream dam is at the same elevation as the top of the downstream dam.
- Keep the maximum height at 2 feet at the center of the dam.
- Keep the center of the check dam at least 12 inches lower than the outer edges at natural ground elevation.
- Keep the side slopes of the check dam at 2H:1V or flatter.
- Key the stone into the ditch banks and extend it beyond the abutments a minimum of 18 inches to avoid washouts from overflow around the dam.
- Use filter fabric foundation under a rock or sand bag check dam. If a blanket ditch liner is used, filter fabric is not necessary. A piece of organic or synthetic blanket cut to fit will also work for this purpose.
- In the case of grass-lined ditches and swales, all check dams and accumulated sediment shall be removed when the grass has matured sufficiently to protect the ditch or swale - unless the slope of the swale is greater than 4 percent. The area beneath the check dams shall be seeded and mulched immediately after dam removal.
- Ensure that channel appurtenances, such as culvert entrances below check dams, are not subject to damage or blockage from displaced stones. [Figure II-4.2.7 Rock Check Dam](#) depicts a typical rock check dam.

### ***Maintenance Standards***

Check dams shall be monitored for performance and sediment accumulation during and after each runoff producing rainfall. Sediment shall be removed when it reaches one half the sump depth.

- Anticipate submergence and deposition above the check dam and erosion from high flows around the edges of the dam.
- If significant erosion occurs between dams, install a protective riprap liner in that portion of the channel.

## ***Approved as Equivalent***

Ecology has approved products as able to meet the requirements of [BMP C207: Check Dams](#). The products did not pass through the Technology Assessment Protocol – Ecology (TAPE) process. Local jurisdictions may choose not to accept this product approved as equivalent, or may require additional testing prior to consideration for local use. The products are available for review on Ecology's website at <http://www.ecy.wa.gov/programs/wq/stormwater/newtech/equivalent.html>

### **Figure II-4.2.7 Rock Check Dam**

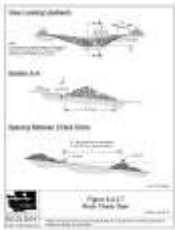

[2014 Figure II-4.2.7 pdf download](#)

---

*Washington State Department of Ecology*

[2012 Stormwater Management Manual for Western Washington, as Amended in December 2014. \(The 2014 SWMMWW\)](#)

## View Looking Upstream

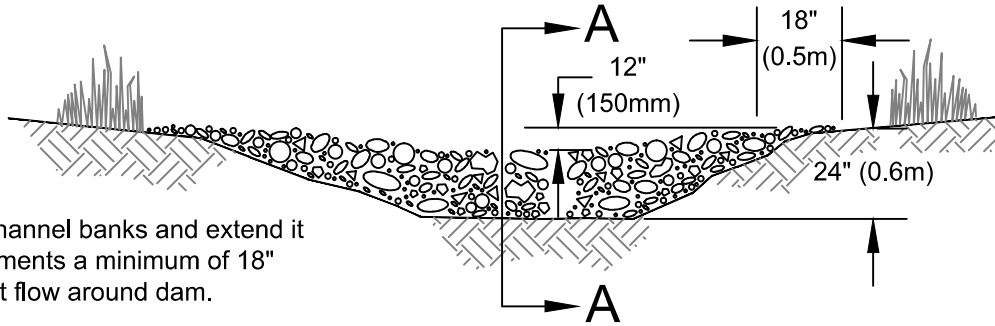

Note:  
Key stone into channel banks and extend it  
beyond the abutments a minimum of 18"  
(0.5m) to prevent flow around dam.

## Section A-A

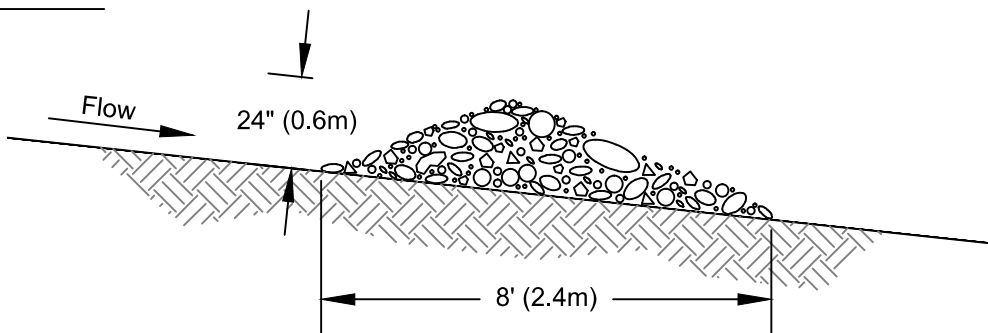

## Spacing Between Check Dams

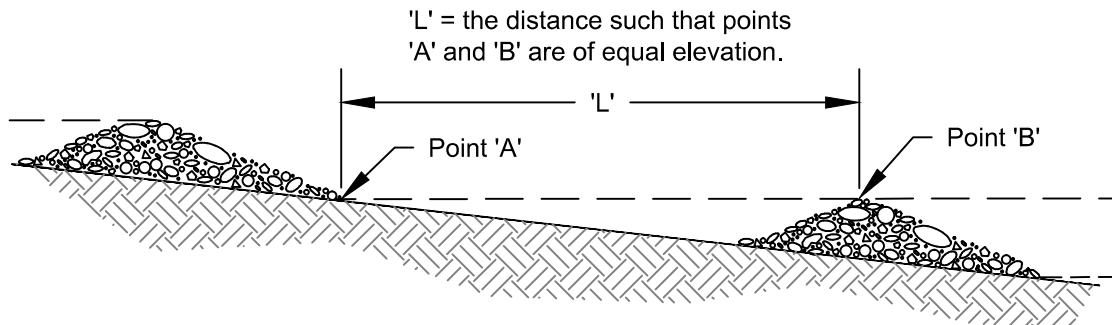

NOT TO SCALE



DEPARTMENT OF  
**ECOLOGY**  
State of Washington

## Figure II-4.2.7 Rock Check Dam

Revised July 2015

Please see <http://www.ecy.wa.gov/copyright.html> for copyright notice including permissions, limitation of liability, and disclaimer.

## **BMP C209: Outlet Protection**

### ***Purpose***

Outlet protection prevents scour at conveyance outlets and minimizes the potential for downstream erosion by reducing the velocity of concentrated stormwater flows.

### ***Conditions of Use***

Use outlet protection at the outlets of all ponds, pipes, ditches, or other conveyances that discharge to a natural or manmade drainage feature such as a stream, wetland, lake, or ditch.

### ***Design and Installation Specifications***

- The receiving channel at the outlet of a pipe shall be protected from erosion by lining a minimum of 6 feet downstream and extending up the channel sides a minimum of 1-foot above the maximum tailwater elevation, or 1-foot above the crown, whichever is higher. For pipes larger than 18 inches in diameter, the outlet protection lining of the channel shall be four times the diameter of the outlet pipe.
- Standard wingwalls, tapered outlets, and paved channels should also be considered when appropriate for permanent culvert outlet protection ([WSDOT, 2015](#)).
- [BMP C122: Nets and Blankets](#) or [BMP C202: Riprap Channel Lining](#) provide suitable options for lining materials.
- With low flows, [BMP C201: Grass-Lined Channels](#) can be an effective alternative for lining material.
- The following guidelines shall be used for outlet protection with riprap:
  - If the discharge velocity at the outlet is less than 5 fps, use 2-inch to 8-inch riprap. Minimum thickness is 1-foot.
  - For 5 to 10 fps discharge velocity at the outlet, use 24-inch to 48-inch riprap. Minimum thickness is 2 feet.
  - For outlets at the base of steep slope pipes (pipe slope greater than 10 percent), use an engineered energy dissipator.
  - Filter fabric or erosion control blankets should always be used under riprap to prevent scour and channel erosion. See [BMP C122: Nets and Blankets](#).
- Bank stabilization, bioengineering, and habitat features may be required for disturbed areas. This work may require a Hydraulic Project Approval (HPA) from the Washington State Department of Fish and Wildlife. See



## ***Maintenance Standards***

- Inspect and repair as needed.
- Add rock as needed to maintain the intended function.
- Clean energy dissipator if sediment builds up.

---

**Washington State Department of Ecology**

*2019 Stormwater Management Manual for Western Washington (2019 SWMMWW)*

Publication No.19-10-021

## BMP C220: Storm Drain Inlet Protection

**Purpose** To prevent coarse sediment from entering drainage systems prior to permanent stabilization of the disturbed area.

**Conditions of Use** Where storm drain inlets are to be made operational before permanent stabilization of the disturbed drainage area. Protection should be provided for all storm drain inlets downslope and within 500 feet of a disturbed or construction area, unless the runoff that enters the catch basin will be conveyed to a sediment pond or trap. Inlet protection may be used anywhere to protect the drainage system. It is likely that the drainage system will still require cleaning.

Table 4.9 lists several options for inlet protection. All of the methods for storm drain inlet protection are prone to plugging and require a high frequency of maintenance. Drainage areas should be limited to 1 acre or less. Emergency overflows may be required where stormwater ponding would cause a hazard. If an emergency overflow is provided, additional end-of-pipe treatment may be required.

<b>Table 4.9 Storm Drain Inlet Protection</b>			
<b>Type of Inlet Protection</b>	<b>Emergency Overflow</b>	<b>Applicable for Paved/ Earthen Surfaces</b>	<b>Conditions of Use</b>
<b>Drop Inlet Protection</b>			
Excavated drop inlet protection	Yes, temporary flooding will occur	Earthen	Applicable for heavy flows. Easy to maintain. Large area Requirement: 30' X 30'/acre
Block and gravel drop inlet protection	Yes	Paved or Earthen	Applicable for heavy concentrated flows. Will not pond.
Gravel and wire drop inlet protection	No		Applicable for heavy concentrated flows. Will pond. Can withstand traffic.
Catch basin filters	Yes	Paved or Earthen	Frequent maintenance required.
<b>Curb Inlet Protection</b>			
Curb inlet protection with a wooden weir	Small capacity overflow	Paved	Used for sturdy, more compact installation.
Block and gravel curb inlet protection	Yes	Paved	Sturdy, but limited filtration.
<b>Culvert Inlet Protection</b>			
Culvert inlet sediment trap			18 month expected life.

***Design and  
Installation  
Specifications***

*Excavated Drop Inlet Protection* - An excavated impoundment around the storm drain. Sediment settles out of the stormwater prior to entering the storm drain.

- Depth 1-2 ft as measured from the crest of the inlet structure.
- Side Slopes of excavation no steeper than 2:1.
- Minimum volume of excavation 35 cubic yards.
- Shape basin to fit site with longest dimension oriented toward the longest inflow area.
- Install provisions for draining to prevent standing water problems.
- Clear the area of all debris.
- Grade the approach to the inlet uniformly.
- Drill weep holes into the side of the inlet.
- Protect weep holes with screen wire and washed aggregate.
- Seal weep holes when removing structure and stabilizing area.
- It may be necessary to build a temporary dike to the down slope side of the structure to prevent bypass flow.

*Block and Gravel Filter* - A barrier formed around the storm drain inlet with standard concrete blocks and gravel. See Figure 4.14.

- Height 1 to 2 feet above inlet.
- Recess the first row 2 inches into the ground for stability.
- Support subsequent courses by placing a 2x4 through the block opening.
- Do not use mortar.
- Lay some blocks in the bottom row on their side for dewatering the pool.
- Place hardware cloth or comparable wire mesh with ½-inch openings over all block openings.
- Place gravel just below the top of blocks on slopes of 2:1 or flatter.
- An alternative design is a gravel donut.
- Inlet slope of 3:1.
- Outlet slope of 2:1.
- 1-foot wide level stone area between the structure and the inlet.
- Inlet slope stones 3 inches in diameter or larger.
- Outlet slope use gravel ½- to ¾-inch at a minimum thickness of 1-foot.

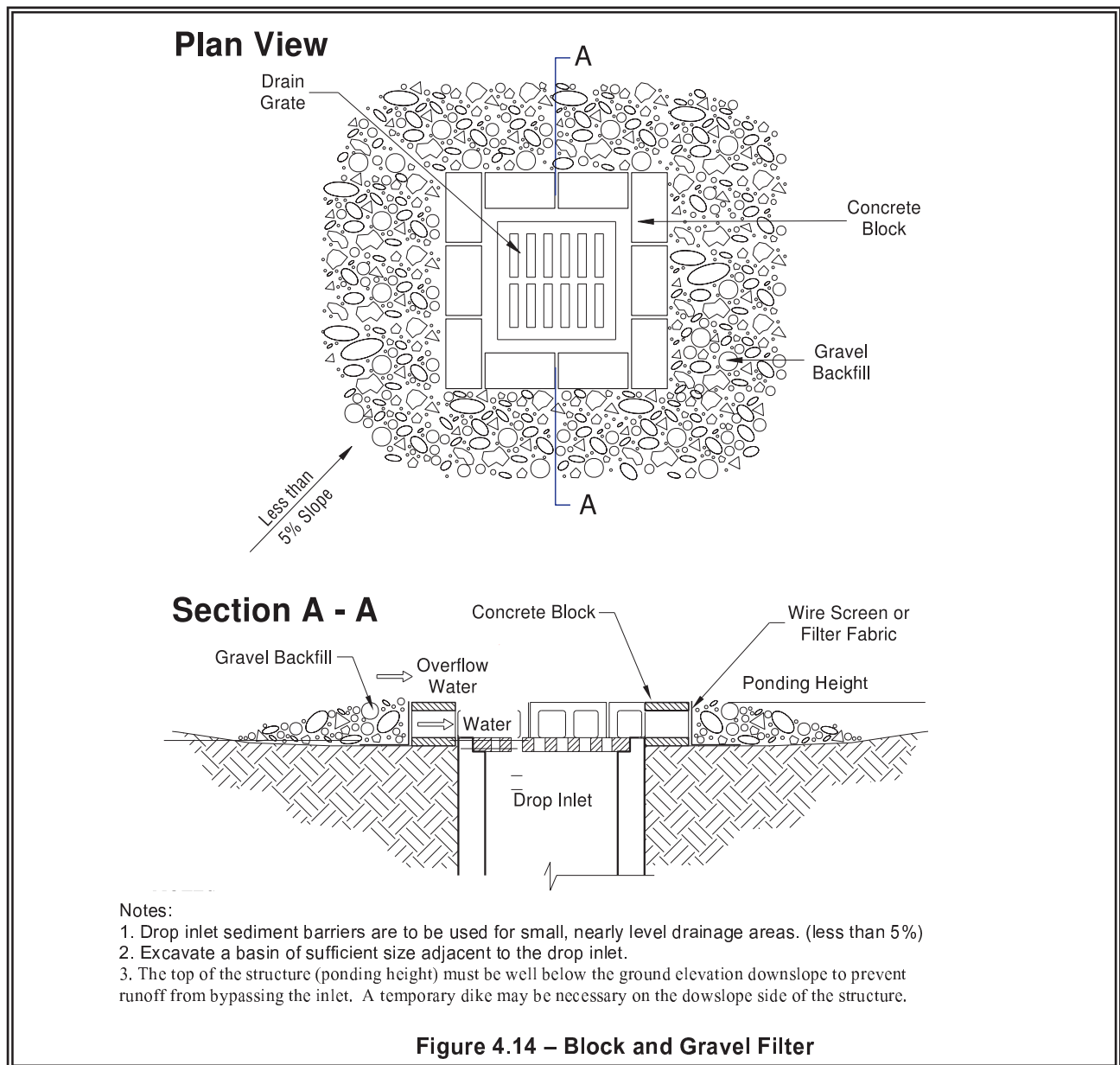

**Figure 4.14 – Block and Gravel Filter**

*Gravel and Wire Mesh Filter* - A gravel barrier placed over the top of the inlet. This structure does not provide an overflow.

- Hardware cloth or comparable wire mesh with ½-inch openings.
- Coarse aggregate.
- Height 1-foot or more, 18 inches wider than inlet on all sides.
- Place wire mesh over the drop inlet so that the wire extends a minimum of 1-foot beyond each side of the inlet structure.
- If more than one strip of mesh is necessary, overlap the strips.
- Place coarse aggregate over the wire mesh.
- The depth of the gravel should be at least 12 inches over the entire inlet opening and extend at least 18 inches on all sides.

*Catchbasin Filters* - Inserts should be designed by the manufacturer for use at construction sites. The limited sediment storage capacity increases the amount of inspection and maintenance required, which may be daily for heavy sediment loads. The maintenance requirements can be reduced by combining a catchbasin filter with another type of inlet protection. This type of inlet protection provides flow bypass without overflow and therefore may be a better method for inlets located along active rights-of-way.

- 5 cubic feet of storage.
- Dewatering provisions.
- High-flow bypass that will not clog under normal use at a construction site.
- The catchbasin filter is inserted in the catchbasin just below the grating.

*Curb Inlet Protection with Wooden Weir* – Barrier formed around a curb inlet with a wooden frame and gravel.

- Wire mesh with ½-inch openings.
- Extra strength filter cloth.
- Construct a frame.
- Attach the wire and filter fabric to the frame.
- Pile coarse washed aggregate against wire/fabric.
- Place weight on frame anchors.

*Block and Gravel Curb Inlet Protection* – Barrier formed around an inlet with concrete blocks and gravel. See Figure 4.14.

- Wire mesh with ½-inch openings.
- Place two concrete blocks on their sides abutting the curb at either side of the inlet opening. These are spacer blocks.
- Place a 2x4 stud through the outer holes of each spacer block to align the front blocks.
- Place blocks on their sides across the front of the inlet and abutting the spacer blocks.
- Place wire mesh over the outside vertical face.
- Pile coarse aggregate against the wire to the top of the barrier.

*Curb and Gutter Sediment Barrier* – Sandbag or rock berm (riprap and aggregate) 3 feet high and 3 feet wide in a horseshoe shape. See Figure 4.16.

- Construct a horseshoe shaped berm, faced with coarse aggregate if using riprap, 3 feet high and 3 feet wide, at least 2 feet from the inlet.
- Construct a horseshoe shaped sedimentation trap on the outside of the berm sized to sediment trap standards for protecting a culvert inlet.

*Maintenance  
Standards*

- Catch basin filters should be inspected frequently, especially after storm events. If the insert becomes clogged, it should be cleaned or replaced.
- For systems using stone filters: If the stone filter becomes clogged with sediment, the stones must be pulled away from the inlet and cleaned or replaced. Since cleaning of gravel at a construction site may be difficult, an alternative approach would be to use the clogged stone as fill and put fresh stone around the inlet.
- Do not wash sediment into storm drains while cleaning. Spread all excavated material evenly over the surrounding land area or stockpile and stabilize as appropriate.

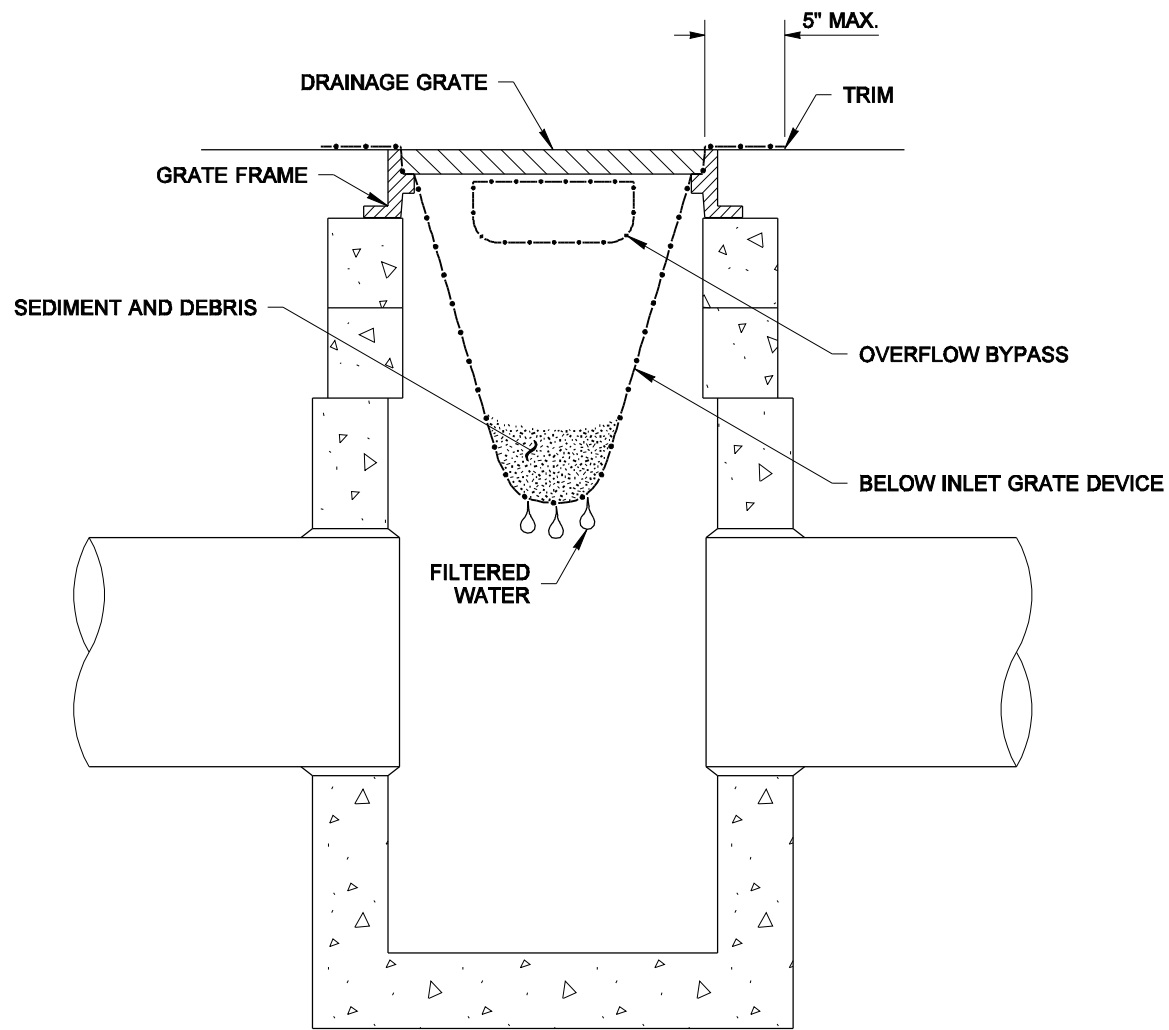

**SECTION VIEW**  
NOT TO SCALE

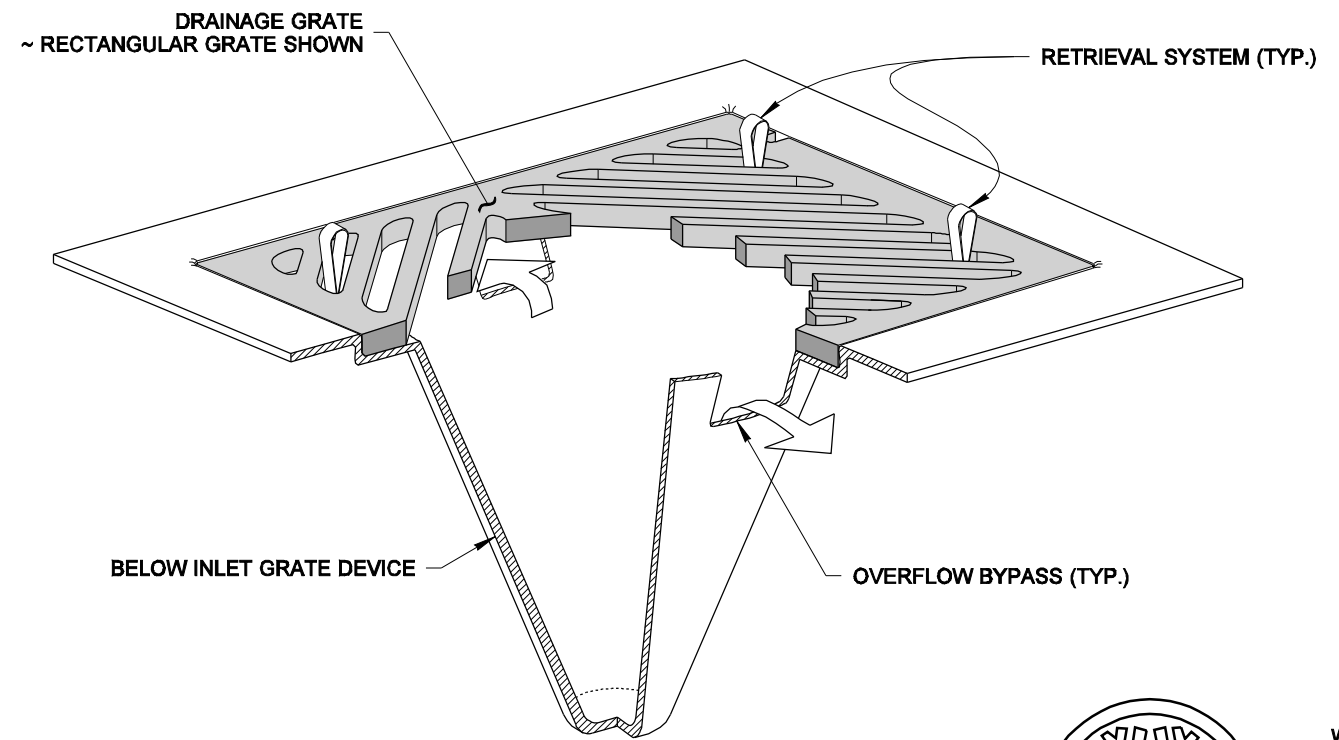

**ISOMETRIC VIEW**

**NOTES**

1. Size the Below Inlet Grate Device (BIGD) for the storm water structure it will service.
2. The BIGD shall have a built-in high-flow relief system (overflow bypass).
3. The retrieval system must allow removal of the BIGD without spilling the collected material.
4. Perform maintenance in accordance with Standard Specification 8-01.3(15).

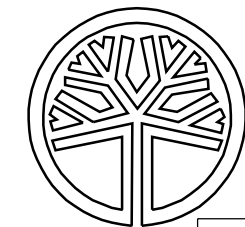

STATE OF WASHINGTON  
REGISTERED  
LANDSCAPE ARCHITECT

MARK W. MAURER  
CERTIFICATE NO. 000598

NOTE: THIS PLAN IS NOT A LEGAL ENGINEERING DOCUMENT BUT AN ELECTRONIC DUPLICATE. THE ORIGINAL, SIGNED BY THE ENGINEER AND APPROVED FOR PUBLICATION, IS KEPT ON FILE AT THE WASHINGTON STATE DEPARTMENT OF TRANSPORTATION. A COPY MAY BE OBTAINED UPON REQUEST.

**STORM DRAIN  
INLET PROTECTION  
STANDARD PLAN I-40.20-00**

SHEET 1 OF 1 SHEET

APPROVED FOR PUBLICATION

**Pasco Bakotich III** 09-20-07  
STATE DESIGN ENGINEER DATE



# BMP C231: Brush Barrier

## *Purpose*

The purpose of brush barriers is to reduce the transport of coarse sediment from a construction site by providing a temporary physical barrier to sediment and reducing the runoff velocities of overland flow.

## *Conditions of Use*

- Brush barriers may be used downslope of all disturbed areas of less than one-quarter acre.
- Brush barriers are not intended to treat concentrated flows, nor are they intended to treat substantial amounts of overland flow. Any concentrated flows must be conveyed through the drainage system to a sediment pond. The only circumstance in which overland flow can be treated solely by a brush barrier, rather than by a sediment pond, is when the area draining to the barrier is small.
- Brush barriers should only be installed on contours.

## *Design and Installation Specifications*

- Height 2 feet (minimum) to 5 feet (maximum).
- Width 5 feet at base (minimum) to 15 feet (maximum).
- Filter fabric (geotextile) may be anchored over the brush berm to enhance the filtration ability of the barrier. Ten-ounce burlap is an adequate alternative to filter fabric.
- Chipped site vegetation, composted mulch, or wood-based mulch (hog fuel) can be used to construct brush barriers.
- A 100 percent biodegradable installation can be constructed using 10-ounce burlap held in place by wooden stakes. [Figure II-4.2.11 Brush Barrier](#) depicts a typical brush barrier.

## *Maintenance Standards*

- There shall be no signs of erosion or concentrated runoff under or around the barrier. If concentrated flows are bypassing the barrier, it must be expanded or augmented by toed-in filter fabric.
- The dimensions of the barrier must be maintained.



## Figure II-4.2.11 Brush Barrier



[2014 Figure II-4.2.11 pdf download](#)

---

*Washington State Department of Ecology*

[2012 Stormwater Management Manual for Western Washington, as Amended in December 2014. \(The 2014 SWMMWW\)](#)

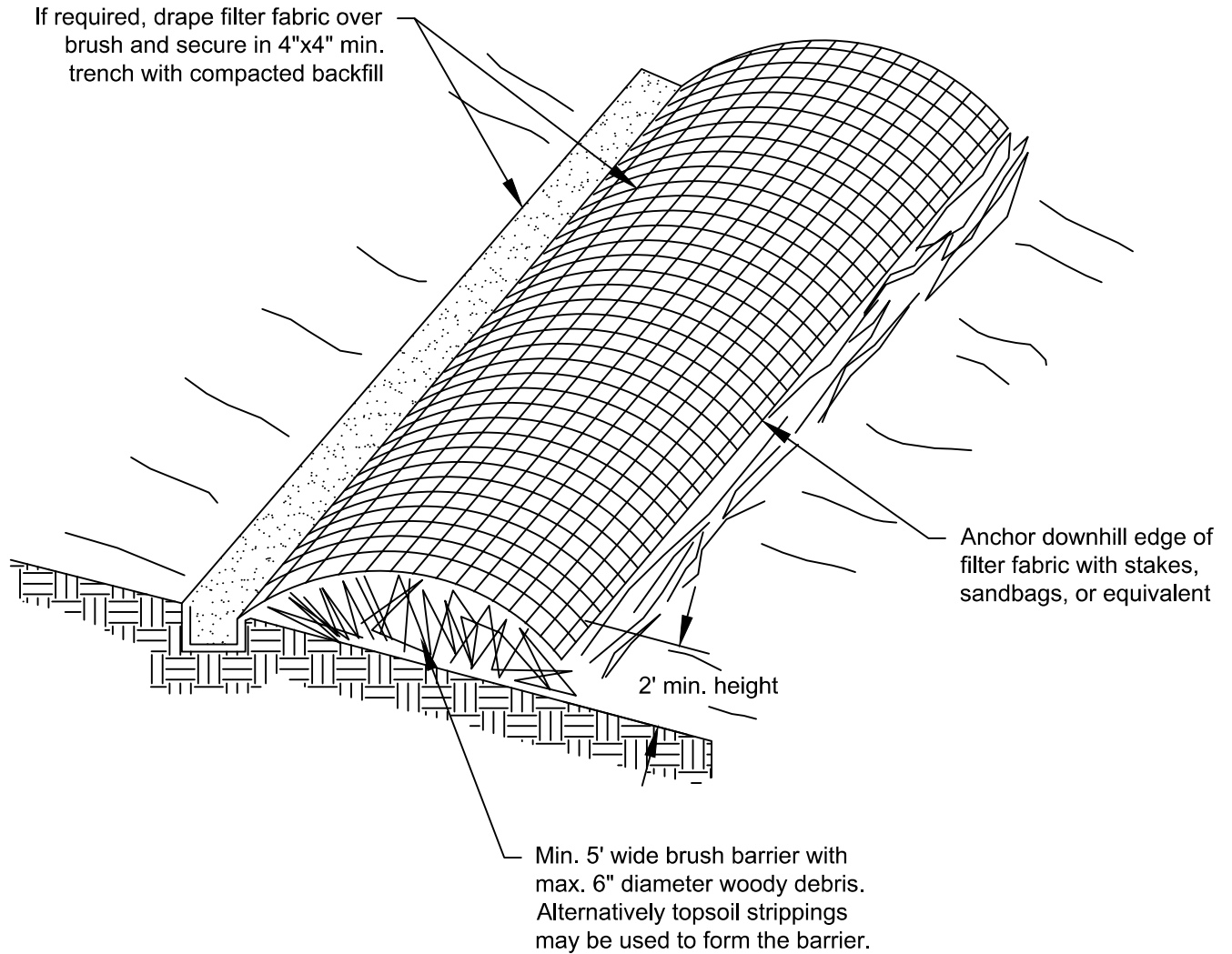

NOT TO SCALE

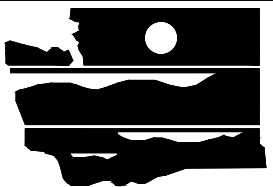

DEPARTMENT OF  
**ECOLOGY**  
State of Washington

## Figure II-4.2.11 Brush Barrier

Revised September 2015

Please see <http://www.ecy.wa.gov/copyright.html> for copyright notice including permissions, limitation of liability, and disclaimer.

# **BMP C232: Gravel Filter Berm**

## ***Purpose***

A gravel filter berm is constructed on rights-of-way or traffic areas within a construction site to retain sediment by using a filter berm of gravel or crushed rock.

## ***Conditions of Use***

Where a temporary measure is needed to retain sediment from rights-of-way or in traffic areas on construction sites.

## ***Design and Installation Specifications***

- Berm material shall be  $\frac{3}{4}$  to 3 inches in size, washed well-grade gravel or crushed rock with less than 5 percent fines.
- Spacing of berms:
  - Every 300 feet on slopes less than 5 percent
  - Every 200 feet on slopes between 5 percent and 10 percent
  - Every 100 feet on slopes greater than 10 percent
- Berm dimensions:
  - 1 foot high with 3H:1V side slopes
  - 8 linear feet per 1 cfs runoff based on the 10-year, 24-hour design storm

## ***Maintenance Standards***

- Regular inspection is required. Sediment shall be removed and filter material replaced as needed.

---

*Washington State Department of Ecology*

[2012 Stormwater Management Manual for Western Washington, as Amended in December 2014 \(The 2014 SWMMWW\)](#)

## BMP C233: Silt Fence

### *Purpose*

Use of a silt fence reduces the transport of coarse sediment from a construction site by providing a temporary physical barrier to sediment and reducing the runoff velocities of overland flow. See Figure 4.19 for details on silt fence construction.

### **Conditions of Use**

Silt fence may be used downslope of all disturbed areas.

- Silt fence is not intended to treat concentrated flows, nor is it intended to treat substantial amounts of overland flow. Any concentrated flows must be conveyed through the drainage system to a sediment pond. The only circumstance in which overland flow can be treated solely by a silt fence, rather than by a sediment pond, is when the area draining to the fence is one acre or less and flow rates are less than 0.5 cfs.
- Silt fences should not be constructed in streams or used in V-shaped ditches. They are not an adequate method of silt control for anything deeper than sheet or overland flow.

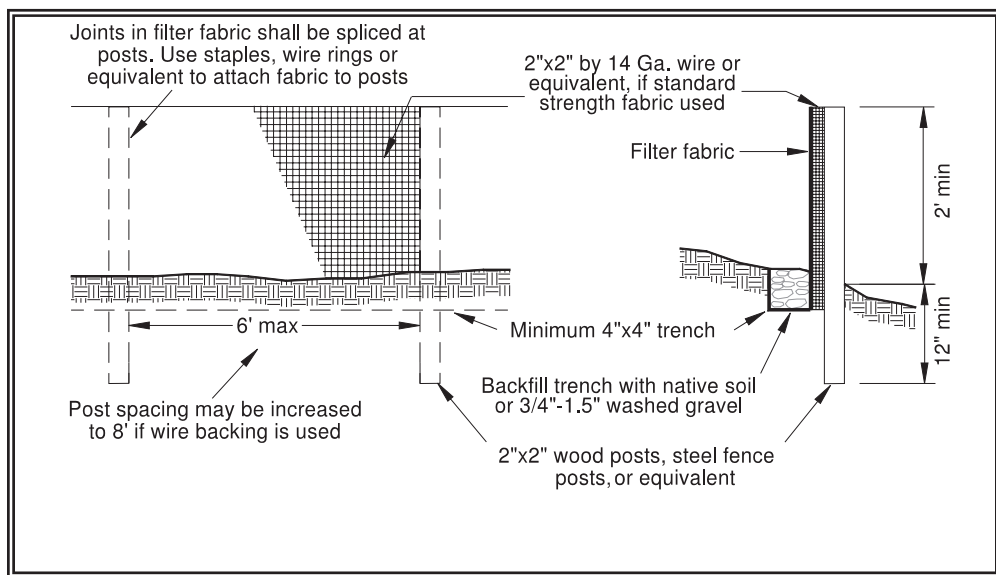

**Figure 4.19 – Silt Fence**

### *Design and Installation Specifications*

- Drainage area of 1 acre or less or in combination with sediment basin in a larger site.
- Maximum slope steepness (normal (perpendicular) to fence line) 1:1.
- Maximum sheet or overland flow path length to the fence of 100 feet.
- No flows greater than 0.5 cfs.
- The geotextile used shall meet the following standards. All geotextile properties listed below are minimum average roll values (i.e., the test result for any sampled roll in a lot shall meet or exceed the values shown in Table 4.10):

<b>Table 4.10 Geotextile Standards</b>	
Polymeric Mesh AOS (ASTM D4751)	0.60 mm maximum for slit film wovens (#30 sieve). 0.30 mm maximum for all other geotextile types (#50 sieve). 0.15 mm minimum for all fabric types (#100 sieve).
Water Permittivity (ASTM D4491)	0.02 sec <sup>-1</sup> minimum
Grab Tensile Strength (ASTM D4632)	180 lbs. Minimum for extra strength fabric. 100 lbs minimum for standard strength fabric.
Grab Tensile Strength (ASTM D4632)	30% maximum
Ultraviolet Resistance (ASTM D4355)	70% minimum

- Standard strength fabrics shall be supported with wire mesh, chicken wire, 2-inch x 2-inch wire, safety fence, or jute mesh to increase the strength of the fabric. Silt fence materials are available that have synthetic mesh backing attached.
- Filter fabric material shall contain ultraviolet ray inhibitors and stabilizers to provide a minimum of six months of expected usable construction life at a temperature range of 0°F. to 120°F.
- 100 percent biodegradable silt fence is available that is strong, long lasting, and can be left in place after the project is completed, if permitted by local regulations.
- Standard Notes for construction plans and specifications follow. Refer to Figure 4.19 for standard silt fence details.

The contractor shall install and maintain temporary silt fences at the locations shown in the Plans. The silt fences shall be constructed in the areas of clearing, grading, or drainage prior to starting those activities. A silt fence shall not be considered temporary if the silt fence must function beyond the life of the contract. The silt fence shall prevent soil carried by runoff water from going beneath, through, or over the top of the silt fence, but shall allow the water to pass through the fence.

The minimum height of the top of silt fence shall be 2 feet and the maximum height shall be 2½ feet above the original ground surface.

The geotextile shall be sewn together at the point of manufacture, or at an approved location as determined by the Engineer, to form geotextile lengths as required. All sewn seams shall be located at a support post. Alternatively, two sections of silt fence can be overlapped, provided the Contractor can demonstrate, to the satisfaction of the Engineer, that the overlap is long enough and that the adjacent fence sections are close enough together to prevent silt laden water from escaping through the fence at the overlap.

The geotextile shall be attached on the up-slope side of the posts and support system with staples, wire, or in accordance with the manufacturer's recommendations. The geotextile shall be attached to the posts in a manner that reduces the potential for geotextile tearing at the staples, wire, or other connection device. Silt fence back-up support for the geotextile in the form of a wire or plastic mesh is dependent on the properties of the geotextile selected for use. If wire or plastic back-up mesh is used, the mesh shall be fastened securely to the up-slope of the posts with the geotextile being up-slope of the mesh back-up support.

The geotextile at the bottom of the fence shall be buried in a trench to a minimum depth of 4 inches below the ground surface. The trench shall be backfilled and the soil tamped in place over the buried portion of the geotextile, such that no flow can pass beneath the fence and scouring can not occur. When wire or polymeric back-up support mesh is used, the wire or polymeric mesh shall extend into the trench a minimum of 3 inches.

The fence posts shall be placed or driven a minimum of 18 inches. A minimum depth of 12 inches is allowed if topsoil or other soft subgrade soil is not present and a minimum depth of 18 inches cannot be reached. Fence post depths shall be increased by 6 inches if the fence is located on slopes of 3:1 or steeper and the slope is perpendicular to the fence. If required post depths cannot be obtained, the posts shall be adequately secured by bracing or guying to prevent overturning of the fence due to sediment loading.

Silt fences shall be located on contour as much as possible, except at the ends of the fence, where the fence shall be turned uphill such that the silt fence captures the runoff water and prevents water from flowing around the end of the fence.

If the fence must cross contours, with the exception of the ends of the fence, gravel check dams placed perpendicular to the back of the fence shall be used to minimize concentrated flow and erosion along the back of the fence. The gravel check dams shall be approximately 1-foot deep at the back of the fence. It shall be continued perpendicular to the fence at the same elevation until the top of the check dam intercepts the ground surface behind the fence. The gravel check dams shall consist of crushed surfacing base course, gravel backfill for walls, or shoulder ballast. The gravel check dams shall be located every 10 feet along the fence where the fence must cross contours. The slope of the fence line where contours must be crossed shall not be steeper than 3:1.

Wood, steel or equivalent posts shall be used. Wood posts shall have minimum dimensions of 2 inches by 2 inches by 3 feet minimum length, and shall be free of defects such as knots, splits, or gouges.

Steel posts shall consist of either size No. 6 rebar or larger, ASTM A 120 steel pipe with a minimum diameter of 1-inch, U, T, L, or C shape steel posts with a minimum weight of 1.35 lbs./ft. or other steel posts having equivalent strength and bending resistance to the post sizes listed. The spacing of the support posts shall be a maximum of 6 feet.

Fence back-up support, if used, shall consist of steel wire with a maximum mesh spacing of 2 inches, or a prefabricated polymeric mesh. The strength of the wire or polymeric mesh shall be equivalent to or greater than 180 lbs. grab tensile strength. The polymeric mesh must be as resistant to ultraviolet radiation as the geotextile it supports.

- Silt fence installation using the slicing method specification details follow. Refer to Figure 4.20 for slicing method details.

The base of both end posts must be at least 2 to 4 inches above the top of the silt fence fabric on the middle posts for ditch checks to drain properly. Use a hand level or string level, if necessary, to mark base points before installation.

Install posts 3 to 4 feet apart in critical retention areas and 6 to 7 feet apart in standard applications.

Install posts 24 inches deep on the downstream side of the silt fence, and as close as possible to the fabric, enabling posts to support the fabric from upstream water pressure.

Install posts with the nipples facing away from the silt fence fabric.

Attach the fabric to each post with three ties, all spaced within the top 8 inches of the fabric. Attach each tie diagonally 45 degrees through the fabric, with each puncture at least 1 inch vertically apart. In addition, each tie should be positioned to hang on a post nipple when tightening to prevent sagging.

Wrap approximately 6 inches of fabric around the end posts and secure with 3 ties.

No more than 24 inches of a 36-inch fabric is allowed above ground level.

The rope lock system must be used in all ditch check applications.

The installation should be checked and corrected for any deviation before compaction. Use a flat-bladed shovel to tuck fabric deeper into the ground if necessary.

Compaction is vitally important for effective results. Compact the soil immediately next to the silt fence fabric with the front wheel of the tractor, skid steer, or roller exerting at least 60 pounds per square inch. Compact the upstream side first and then each side twice for a total of four trips.

**Maintenance Standards**

- Any damage shall be repaired immediately.
- If concentrated flows are evident uphill of the fence, they must be intercepted and conveyed to a sediment pond.
- It is important to check the uphill side of the fence for signs of the fence clogging and acting as a barrier to flow and then causing channelization of flows parallel to the fence. If this occurs, replace the fence or remove the trapped sediment.
- Sediment deposits shall either be removed when the deposit reaches approximately one-third the height of the silt fence, or a second silt fence shall be installed.
- If the filter fabric (geotextile) has deteriorated due to ultraviolet breakdown, it shall be replaced.

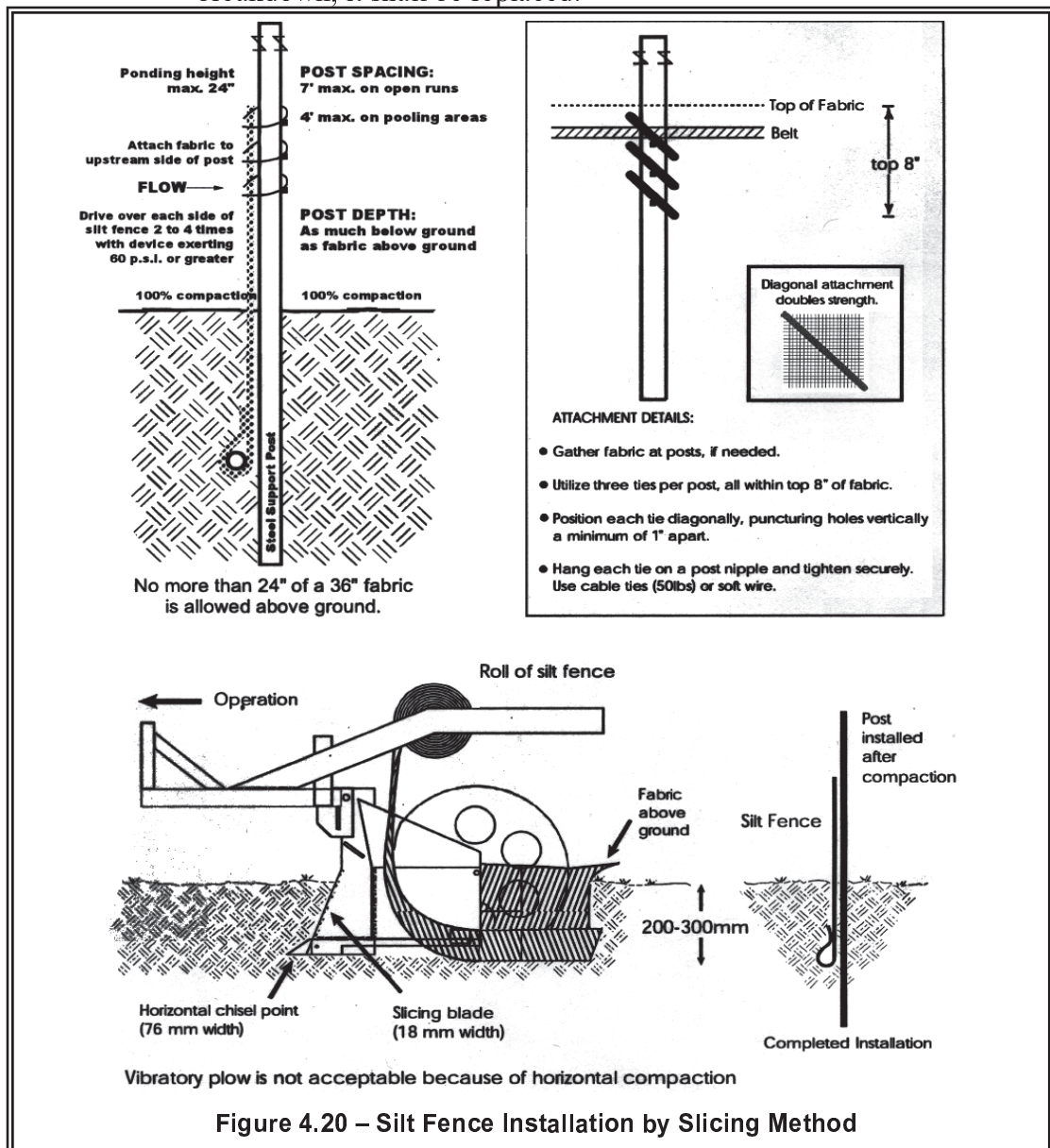



# BMP C234: Vegetated Strip

## Purpose

Vegetated strips reduce the transport of coarse sediment from a construction site by providing a temporary physical barrier to sediment and reducing the runoff velocities of overland flow.

## Conditions of Use

- Vegetated strips may be used downslope of all disturbed areas.
- Vegetated strips are not intended to treat concentrated flows, nor are they intended to treat substantial amounts of overland flow. Any concentrated flows must be conveyed through the drainage system to a sediment pond. The only circumstance in which overland flow can be treated solely by a strip, rather than by a sediment pond, is when the following criteria are met (see [Table II-4.2.4 Contributing Drainage Area for Vegetated Strips](#)):

**Table II-4.2.4 Contributing Drainage Area for Vegetated Strips**

Average Contributing Area Slope	Average Contributing Area Percent Slope	Max Contributing area Flowpath Length
1.5H : 1V or flatter	67% or flatter	100 feet
2H : 1V or flatter	50% or flatter	115 feet
4H : 1V or flatter	25% or flatter	150 feet
6H : 1V or flatter	16.7% or flatter	200 feet
10H : 1V or flatter	10% or flatter	250 feet

## Design and Installation Specifications

- The vegetated strip shall consist of a minimum of a 25-foot flowpath length continuous strip of dense vegetation with topsoil. Grass-covered, landscaped areas are generally not adequate because the volume of sediment overwhelms the grass. Ideally, vegetated strips shall consist of undisturbed native growth with a well-developed soil that allows for infiltration of runoff.
- The slope within the strip shall not exceed 4H:1V.
- The uphill boundary of the vegetated strip shall be delineated with clearing limits.

## Maintenance Standards

- Any areas damaged by erosion or construction activity shall be seeded immediately and protected by mulch.

- If more than 5 feet of the original vegetated strip width has had vegetation removed or is being eroded, sod must be installed.
- If there are indications that concentrated flows are traveling across the buffer, surface water controls must be installed to reduce the flows entering the buffer, or additional perimeter protection must be installed.

---

*Washington State Department of Ecology*

[2012 Stormwater Management Manual for Western Washington, as Amended in December 2014. \(The 2014 SWMMWW\)](#)

# BMP C235: Wattles

## *Purpose*

Wattles are temporary erosion and sediment control barriers consisting of straw, compost, or other material that is wrapped in biodegradable tubular plastic or similar encasing material. They reduce the velocity and can spread the flow of rill and sheet runoff, and can capture and retain sediment. Wattles are typically 8 to 10 inches in diameter and 25 to 30 feet in length. Wattles are placed in shallow trenches and staked along the contour of disturbed or newly constructed slopes. See [Figure II-4.2.14 Wattles](#) for typical construction details. WSDOT Standard Plan I-30.30-00 also provides information on Wattles (<http://www.wsdot.wa.gov/Design/Standards/Plans.htm#SectionI>)

## *Conditions of Use*

- Use wattles:
  - In disturbed areas that require immediate erosion protection.
  - On exposed soils during the period of short construction delays, or over winter months.
  - On slopes requiring stabilization until permanent vegetation can be established.
- The material used dictates the effectiveness period of the wattle. Generally, Wattles are typically effective for one to two seasons.
- Prevent rilling beneath wattles by properly entrenching and abutting wattles together to prevent water from passing between them.

## *Design Criteria*

- Install wattles perpendicular to the flow direction and parallel to the slope contour.
- Narrow trenches should be dug across the slope on contour to a depth of 3- to 5-inches on clay soils and soils with gradual slopes. On loose soils, steep slopes, and areas with high rainfall, the trenches should be dug to a depth of 5- to 7- inches, or 1/2 to 2/3 of the thickness of the wattle.
- Start building trenches and installing wattles from the base of the slope and work up. Spread excavated material evenly along the uphill slope and compacted using hand tamping or other methods.
- Construct trenches at intervals of 10- to 25-feet depending on the steepness of the slope, soil type, and rainfall. The steeper the slope the closer together the trenches.

- Install the wattles snugly into the trenches and abut tightly end to end. Do not overlap the ends.
- Install stakes at each end of the wattle, and at 4-foot centers along entire length of wattle.
- If required, install pilot holes for the stakes using a straight bar to drive holes through the wattle and into the soil.
- Wooden stakes should be approximately 3/4 x 3/4 x 24 inches min. Willow cuttings or 3/8-inch rebar can also be used for stakes.
- Stakes should be driven through the middle of the wattle, leaving 2 to 3 inches of the stake protruding above the wattle.

### ***Maintenance Standards***

- Wattles may require maintenance to ensure they are in contact with soil and thoroughly entrenched, especially after significant rainfall on steep sandy soils.

**Figure II-4.2.14 Wattles**



[2014 Figure II-4.2.14 pdf download](#)

- Inspect the slope after significant storms and repair any areas where wattles are not tightly abutted or water has scoured beneath the wattles.

### ***Approved as Equivalent***

Ecology has approved products as able to meet the requirements of [BMP C235: Wattles](#). The products did not pass through the Technology Assessment Protocol – Ecology (TAPE) process. Local jurisdictions may choose not to accept this product approved as equivalent, or may require additional testing prior to consideration for local use. The products are available for review on Ecology’s website at <http://www.ecy.wa.gov/programs/wq/stormwater/newtech/equivalent.html>

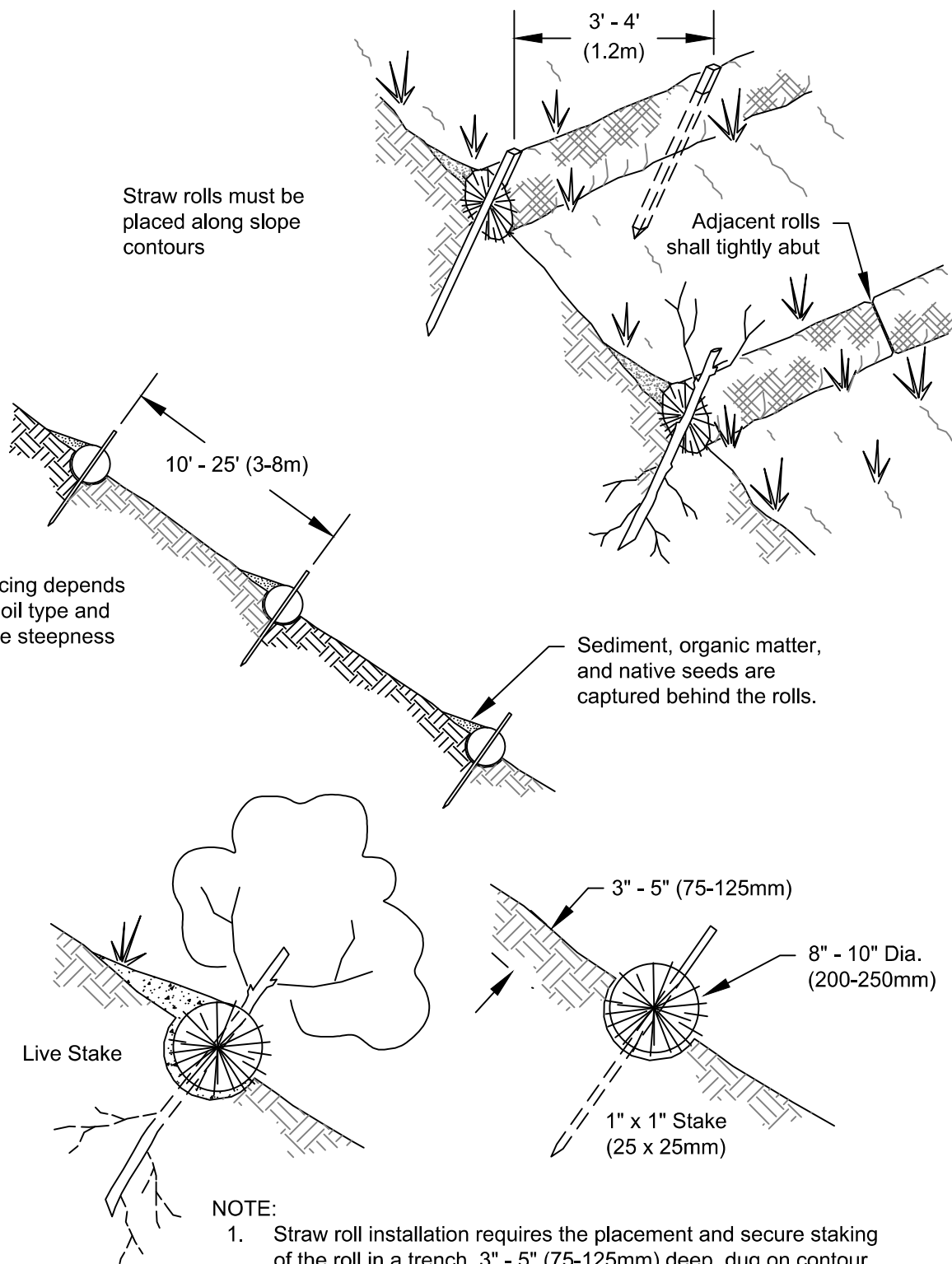

NOT TO SCALE

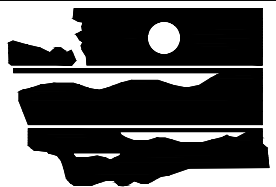

DEPARTMENT OF  
**ECOLOGY**  
State of Washington

## Figure II-4.2.14 Wattles

Revised November 2015

Please see <http://www.ecy.wa.gov/copyright.html> for copyright notice including permissions, limitation of liability, and disclaimer.

## **BMP C236: Vegetative Filtration**

### ***Purpose***

Vegetative filtration as a BMP is used in conjunction with detention storage in the form of portable tanks or [BMP C241: Sediment Pond \(Temporary\)](#), [BMP C206: Level Spreader](#), and a pumping system with surface intake. Vegetative filtration improves turbidity levels of stormwater discharges by filtering runoff through existing vegetation where undisturbed forest floor duff layer or established lawn with thatch layer are present. Vegetative filtration can also be used to infiltrate dewatering waste from foundations, vaults, and trenches as long as runoff does not occur.

### ***Conditions of Use***

- For every five acres of disturbed soil use one acre of grass field, farm pasture, or wooded area. Reduce or increase this area depending on project size, ground water table height, and other site conditions.
- Wetlands shall not be used for vegetative filtration.
- Do not use this BMP in areas with a high ground water table, or in areas that will have a high seasonal ground water table during the use of this BMP.
- This BMP may be less effective on soils that prevent the infiltration of the water, such as hard till.
- Using other effective source control measures throughout a construction site will prevent the generation of additional highly turbid water and may reduce the time period or area need for this BMP.
- Stop distributing water into the vegetated filtration area if standing water or erosion results.
- On large projects that phase the clearing of the site, areas retained with native vegetation may be used as a temporary vegetative filtration area.

### ***Design Criteria***

- Find land adjacent to the project site that has a vegetated field, preferably a farm field, or wooded area.
- If the site does not contain enough vegetated field area consider obtaining permission from adjacent landowners (especially for farm fields).
- Install a pump and downstream distribution manifold depending on the project size. Generally, the main distribution line should reach 100 to 200-feet long (large projects, or projects on tight soil, will require systems that reach several thousand feet long with numerous branch lines off of the main distribution line).
- The manifold should have several valves, allowing for control over the distribution area in the field.

- Install several branches of 4-inch diameter schedule 20 polyvinyl chloride (PVC), swaged-fit common septic tight-lined sewer line, or 6-inch diameter fire hose, which can convey the turbid water out to various sections of the field. See [Figure II-3.25: Manifold and Branches in a Wooded, Vegetated Spray Field](#).
- Determine the branch length based on the field area geography and number of branches. Typically, branches stretch from 200-feet to several thousand feet. Lay the branches on contour with the slope.
- On uneven ground, sprinklers perform well. Space sprinkler heads so that spray patterns do not overlap.
- On relatively even surfaces, a level spreader using 4-inch perforated pipe may be used as an alternative option to the sprinkler head setup. Install drain pipe at the highest point on the field and at various lower elevations to ensure full coverage of the filtration area. Place the pipe with the holes up to allow for gentle weeping evenly out all holes. Leveling the pipe by staking and using sandbags may be required.
- To prevent over saturating of the vegetative filtration area, rotate the use of branches or spray heads. Repeat as needed based on monitoring the spray field.

**Table II-3.13: Flowpath Guidelines for Vegetative Filtration**

Average Slope	Average Area % Slope	Estimated Flowpath Length (ft)
1.5H:1V	67%	250
2H:1V	50%	200
4H:1V	25%	150
6H:1V	16.7%	115
10H:1V	10%	100

**Figure II-3.25: Manifold and Branches in a Wooded, Vegetated Spray Field**



[pdf download](#)

## **Maintenance Standards**

- Monitor the spray field on a daily basis to ensure that over saturation of any portion of the field doesn't occur at any time. The presence of standing puddles of water or creation of concentrated flows visually signify that over saturation of the field has occurred.

- Monitor the vegetated spray field all the way down to the nearest surface water, or farthest spray area, to ensure that the water has not caused overland or concentrated flows, and has not created erosion around the spray nozzle(s).
- Do not exceed water quality standards for turbidity.
- Ecology recommends that a separate inspection log be developed, maintained and kept with the existing site logbook to aid the operator conducting inspections. This separate “Field Filtration Logbook” can also aid in demonstrating compliance with permit conditions.
- Inspect the spray nozzles daily, at a minimum, for leaks and plugging from sediment particles.
- If erosion, concentrated flows, or over saturation of the field occurs, rotate the use of branches or spray heads or move the branches to a new field location.
- Check all branches and the manifold for unintended leaks.

---

**Washington State Department of Ecology**

*2019 Stormwater Management Manual for Western Washington (2019 SWMMWW)*

Publication No.19-10-021



## **BMP C240: Sediment Trap**

### ***Purpose***

A sediment trap is a small temporary ponding area with a gravel outlet used to collect and store sediment from sites cleared and/or graded during construction. Sediment traps, along with other perimeter controls, shall be installed before any land disturbance takes place in the drainage area.

### ***Conditions of Use***

Prior to leaving a construction site, stormwater runoff must pass through a sediment pond or trap or other appropriate sediment removal best management practice. Non-engineered sediment traps may be used on-site prior to an engineered sediment trap or sediment pond to provide additional sediment removal capacity.

It is intended for use on sites where the tributary drainage area is less than 3 acres, with no unusual drainage features, and a projected build-out time of six months or less. The sediment trap is a temporary measure (with a design life of approximately 6 months) and shall be maintained until the site area is permanently protected against erosion by vegetation and/or structures.

Sediment traps and ponds are only effective in removing sediment down to about the medium silt size fraction. Runoff with sediment of finer grades (fine silt and clay) will pass through untreated, emphasizing the need to control erosion to the maximum extent first.

Whenever possible, sediment-laden water shall be discharged into onsite, relatively level, vegetated areas (see BMP C234 – Vegetated Strip). This is the only way to effectively remove fine particles from runoff unless chemical treatment or filtration is used. This can be particularly useful after initial treatment in a sediment trap or pond. The areas of release must be evaluated on a site-by-site basis in order to determine appropriate locations for and methods of releasing runoff. Vegetated wetlands shall not be used for this purpose. Frequently, it may be possible to pump water from the collection point at the downhill end of the site to an upslope vegetated area. Pumping shall only augment the treatment system, not replace it, because of the possibility of pump failure or runoff volume in excess of pump capacity.

All projects that are constructing permanent facilities for runoff quantity control should use the rough-graded or final-graded permanent facilities for traps and ponds. This includes combined facilities and infiltration facilities. When permanent facilities are used as temporary sedimentation facilities, the surface area requirement of a sediment trap or pond must be met. If the surface area requirements are larger than the surface area of the permanent facility, then the trap or pond shall be enlarged to comply with the surface area requirement. The permanent pond shall also be divided into two cells as required for sediment ponds.

Either a permanent control structure or the temporary control structure (described in BMP C241, Temporary Sediment Pond) can be used. If a permanent control structure is used, it may be advisable to partially restrict the lower orifice with gravel to increase residence time while still allowing dewatering of the pond. A shut-off valve may be added to the control structure to allow complete retention of stormwater in emergency situations. In this case, an emergency overflow weir must be added.

A skimmer may be used for the sediment trap outlet if approved by the Local Permitting Authority.

***Design and  
Installation  
Specifications***

- See Figures 4.22 and 4.23 for details.
- If permanent runoff control facilities are part of the project, they should be used for sediment retention.
- To determine the sediment trap geometry, first calculate the design surface area ( $SA$ ) of the trap, measured at the invert of the weir. Use the following equation:

$$SA = FS(Q_2/V_s)$$

where

$Q_2$  = Design inflow based on the peak discharge from the developed 2-year runoff event from the contributing drainage area as computed in the hydrologic analysis. The 10-year peak flow shall be used if the project size, expected timing and duration of construction, or downstream conditions warrant a higher level of protection. If no hydrologic analysis is required, the Rational Method may be used.

$V_s$  = The settling velocity of the soil particle of interest. The 0.02 mm (medium silt) particle with an assumed density of 2.65 g/cm<sup>3</sup> has been selected as the particle of interest and has a settling velocity ( $V_s$ ) of 0.00096 ft/sec.

$FS$  = A safety factor of 2 to account for non-ideal settling.

Therefore, the equation for computing surface area becomes:

$$SA = 2 \times Q_2 / 0.00096 \text{ or}$$

2080 square feet per cfs of inflow

Note: Even if permanent facilities are used, they must still have a surface area that is at least as large as that derived from the above formula. If they do not, the pond must be enlarged.

- To aid in determining sediment depth, all sediment traps shall have a staff gauge with a prominent mark 1-foot above the bottom of the trap.

- Sediment traps may not be feasible on utility projects due to the limited work space or the short-term nature of the work. Portable tanks may be used in place of sediment traps for utility projects.

**Maintenance Standards**

- Sediment shall be removed from the trap when it reaches 1-foot in depth.
- Any damage to the pond embankments or slopes shall be repaired.

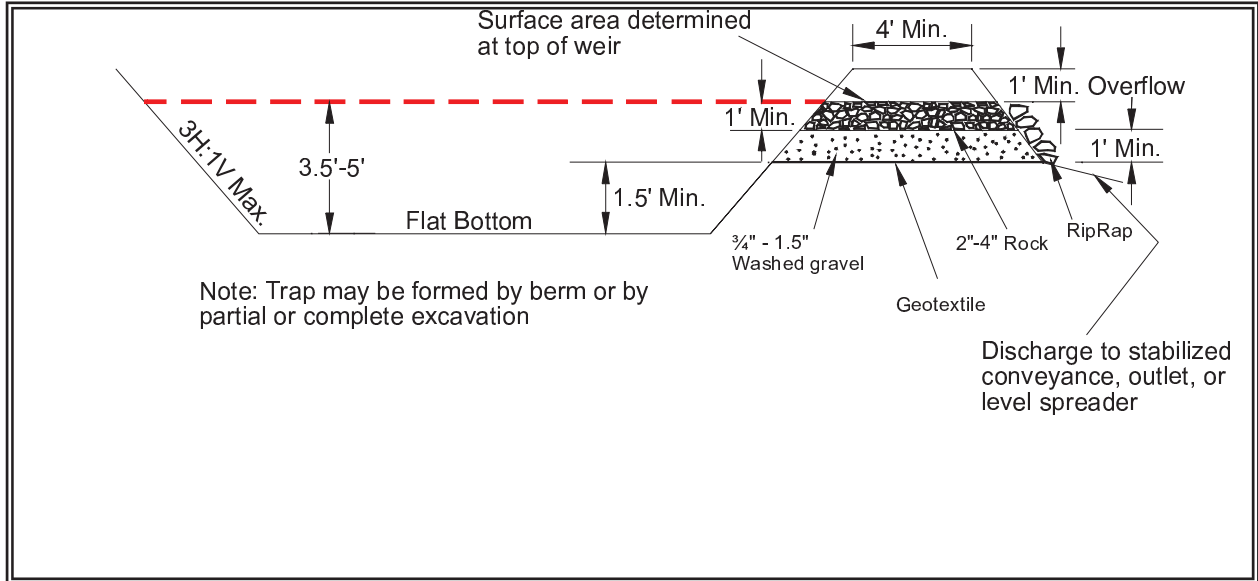

**Figure 4.22 Cross Section of Sediment Trap**

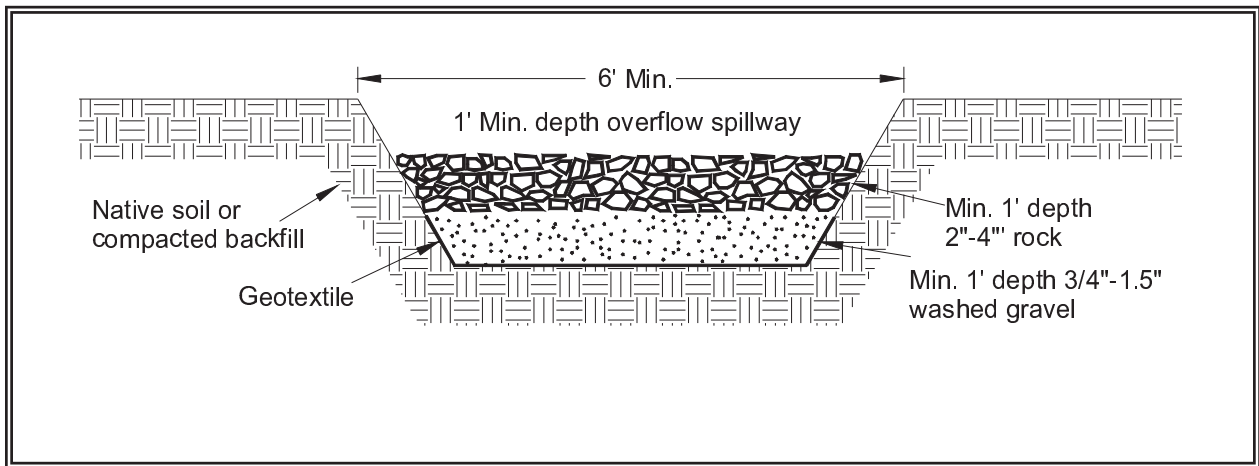

**Figure 4.23 Sediment Trap Outlet**

## **BMP C241: Temporary Sediment Pond**

### ***Purpose***

Sediment ponds remove sediment from runoff originating from disturbed areas of the site. Sediment ponds are typically designed to remove sediment no smaller than medium silt (0.02 mm). Consequently, they usually reduce turbidity only slightly.

### ***Conditions of Use***

Prior to leaving a construction site, stormwater runoff must pass through a sediment pond or other appropriate sediment removal best management practice.

A sediment pond shall be used where the contributing drainage area is 3 acres or more. Ponds must be used in conjunction with erosion control practices to reduce the amount of sediment flowing into the basin.

### ***Design and Installation Specifications***

- Sediment basins must be installed only on sites where failure of the structure would not result in loss of life, damage to homes or buildings, or interruption of use or service of public roads or utilities. Also, sediment traps and ponds are attractive to children and can be very dangerous. Compliance with local ordinances regarding health and safety must be addressed. If fencing of the pond is required, the type of fence and its location shall be shown on the ESC plan.
- Structures having a maximum storage capacity at the top of the dam of 10 acre-ft (435,600 ft<sup>3</sup>) or more are subject to the Washington Dam Safety Regulations (Chapter 173-175 WAC).
- See Figure 4.24, Figure 4.25, and Figure 4.26 for details.
- If permanent runoff control facilities are part of the project, they should be used for sediment retention. The surface area requirements of the sediment basin must be met. This may require enlarging the permanent basin to comply with the surface area requirements. If a permanent control structure is used, it may be advisable to partially restrict the lower orifice with gravel to increase residence time while still allowing dewatering of the basin.
- Use of infiltration facilities for sedimentation basins during construction tends to clog the soils and reduce their capacity to infiltrate. If infiltration facilities are to be used, the sides and bottom of the facility must only be rough excavated to a minimum of 2 feet above final grade. Final grading of the infiltration facility shall occur only when all contributing drainage areas are fully stabilized. The infiltration pretreatment facility should be fully constructed and used with the sedimentation basin to help prevent clogging.
- Determining Pond Geometry  
Obtain the discharge from the hydrologic calculations of the peak flow for the 2-year runoff event ( $Q_2$ ). The 10-year peak flow shall be used if the project size, expected timing and duration of construction, or downstream conditions warrant a higher level of protection. If no hydrologic analysis is required, the Rational Method may be used.

Determine the required surface area at the top of the riser pipe with the equation:

$$SA = \frac{2 \times Q_2}{0.00096} \quad \text{or} \\ 2080 \text{ square feet per cfs of inflow}$$

See BMP C240 for more information on the derivation of the surface area calculation.

The basic geometry of the pond can now be determined using the following design criteria:

- Required surface area SA (from Step 2 above) at top of riser.
- Minimum 3.5-foot depth from top of riser to bottom of pond.
- Maximum 3:1 interior side slopes and maximum 2:1 exterior slopes. The interior slopes can be increased to a maximum of 2:1 if fencing is provided at or above the maximum water surface.
- One foot of freeboard between the top of the riser and the crest of the emergency spillway.
- Flat bottom.
- Minimum 1-foot deep spillway.
- Length-to-width ratio between 3:1 and 6:1.
- Sizing of Discharge Mechanisms.

The outlet for the basin consists of a combination of principal and emergency spillways. These outlets must pass the peak runoff expected from the contributing drainage area for a 100-year storm. If, due to site conditions and basin geometry, a separate emergency spillway is not feasible, the principal spillway must pass the entire peak runoff expected from the 100-year storm. However, an attempt to provide a separate emergency spillway should always be made. The runoff calculations should be based on the site conditions during construction. The flow through the dewatering orifice cannot be utilized when calculating the 100-year storm elevation because of its potential to become clogged; therefore, available spillway storage must begin at the principal spillway riser crest.

The principal spillway designed by the procedures contained in this standard will result in some reduction in the peak rate of runoff. However, the riser outlet design will not adequately control the basin discharge to the predevelopment discharge limitations as stated in Minimum Requirement #7: Flow Control. However, if the basin for a permanent stormwater detention pond is used for a temporary sedimentation basin, the control structure for the permanent pond can be used to maintain predevelopment discharge limitations. The size of the basin, the expected life of the construction project, the anticipated downstream effects and the anticipated weather conditions during construction, should be considered to determine the need of additional discharge control. See Figure 4.28 for riser inflow curves.

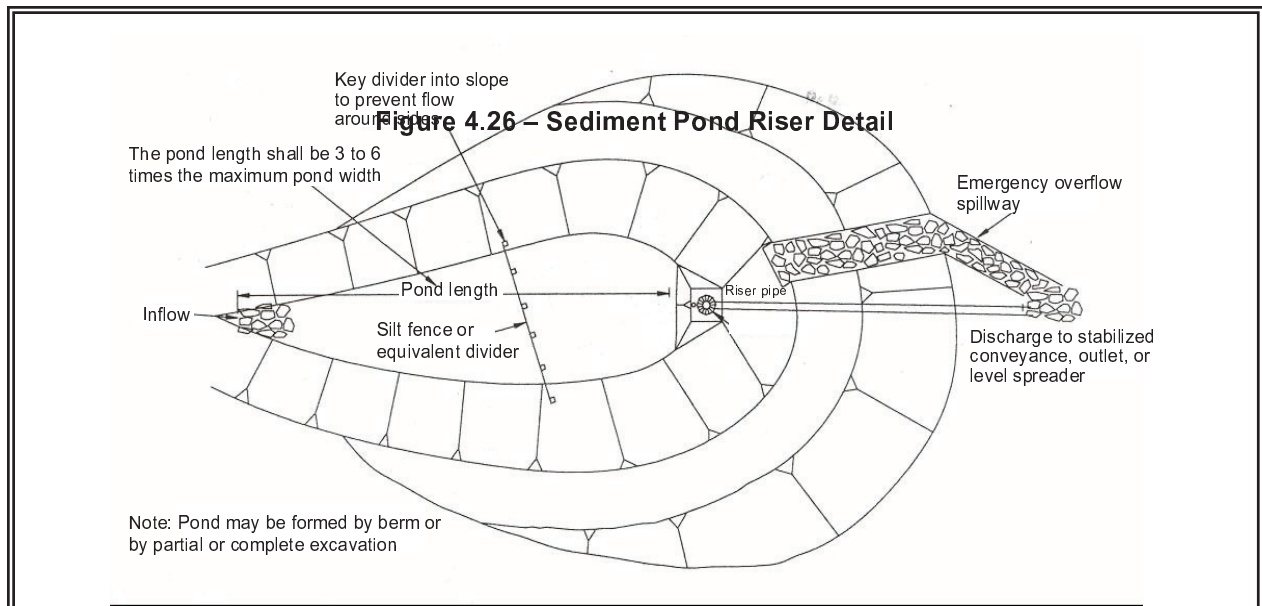

Figure 4.24 – Sediment Pond Plan View

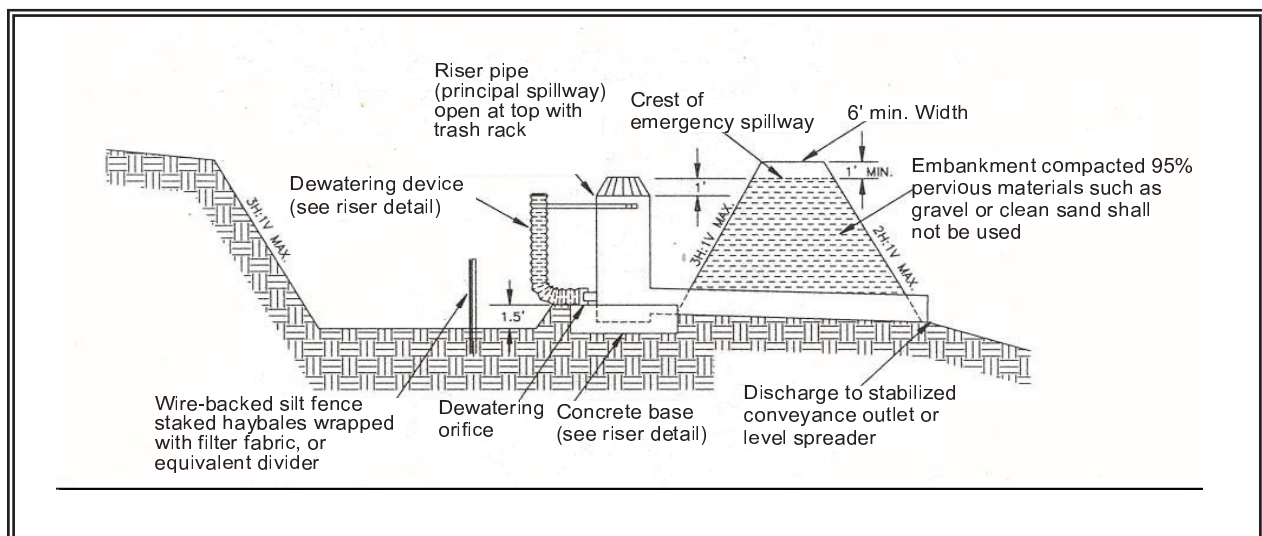

Figure 4.25 – Sediment Pond Cross Section

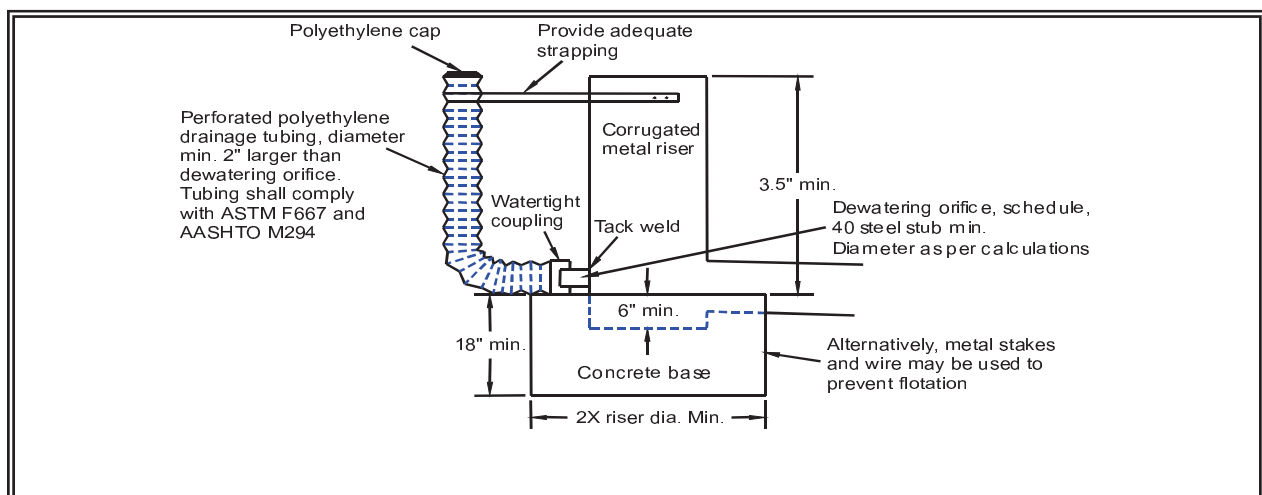

Figure 4.26 – Sediment Pond Riser Detail

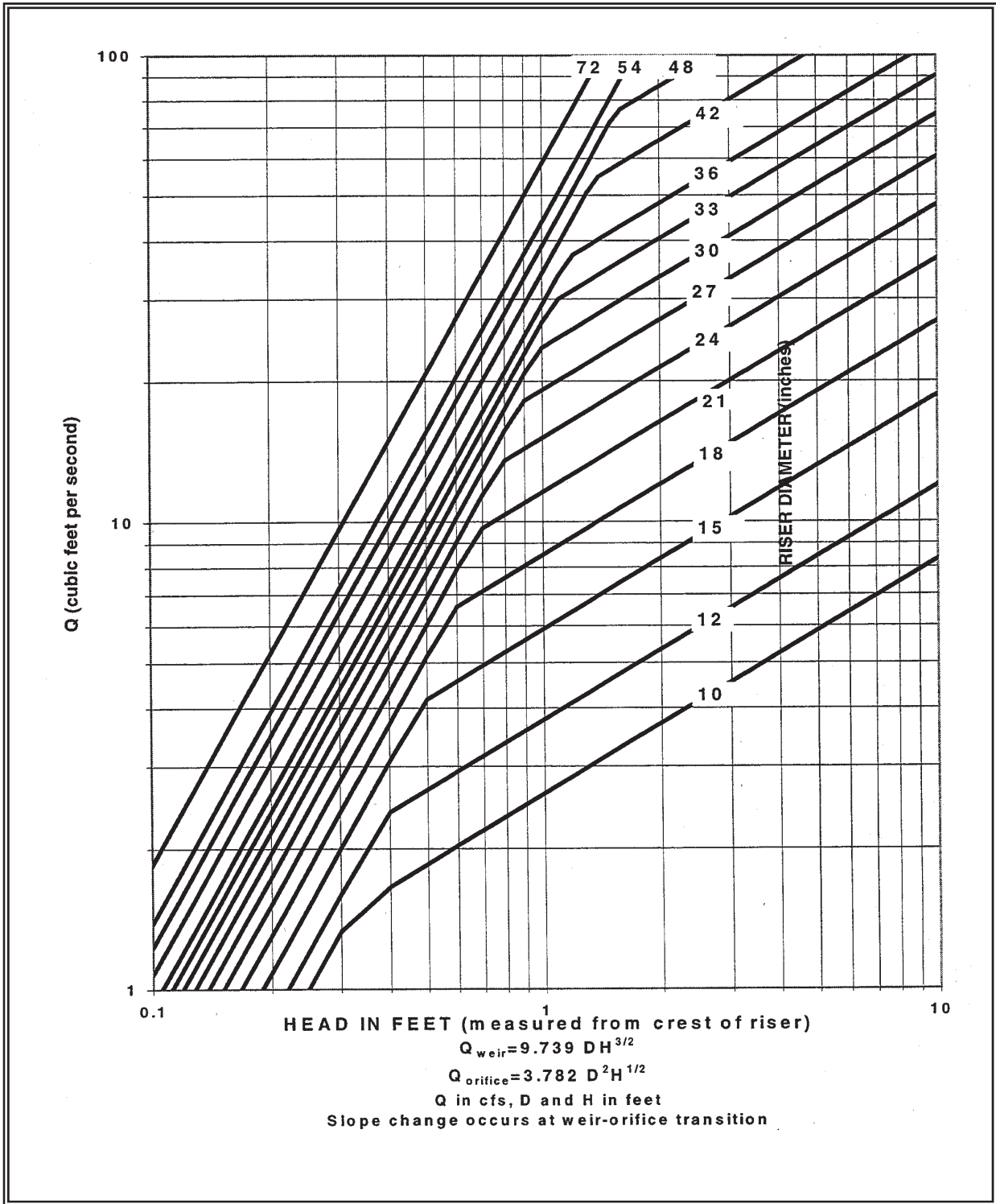

Figure 4.27 – Riser Inflow Curves

**Principal Spillway:** Determine the required diameter for the principal spillway (riser pipe). The diameter shall be the minimum necessary to pass the pre-developed 10-year peak flow ( $Q_{10}$ ). Use Figure 4.28 to determine this diameter ( $h = 1$ -foot). *Note: A permanent control structure may be used instead of a temporary riser.*

**Emergency Overflow Spillway:** Determine the required size and design of the emergency overflow spillway for the developed 100-year peak flow using the method contained in Volume III.

**Dewatering Orifice:** Determine the size of the dewatering orifice(s) (minimum 1-inch diameter) using a modified version of the discharge equation for a vertical orifice and a basic equation for the area of a circular orifice. Determine the required area of the orifice with the following equation:

$$A_o = \frac{A_s (2h)^{0.5}}{0.6 \times 3600 T g^{0.5}}$$

where  $A_o$  = orifice area (square feet)  
 $A_s$  = pond surface area (square feet)  
 $h$  = head of water above orifice (height of riser in feet)  
 $T$  = dewatering time (24 hours)  
 $g$  = acceleration of gravity (32.2 feet/second<sup>2</sup>)

Convert the required surface area to the required diameter  $D$  of the orifice:

$$D = 24 \times \sqrt{\frac{A_o}{\pi}} = 13.54 \times \sqrt{A_o}$$

The vertical, perforated tubing connected to the dewatering orifice must be at least 2 inches larger in diameter than the orifice to improve flow characteristics. The size and number of perforations in the tubing should be large enough so that the tubing does not restrict flow. The orifice should control the flow rate.

- **Additional Design Specifications**

The **pond shall be divided** into two roughly equal volume cells by a permeable divider that will reduce turbulence while allowing movement of water between cells. The divider shall be at least one-half the height of the riser and a minimum of one foot below the top of the riser. Wire-backed, 2- to 3-foot high, extra strength filter fabric supported by treated 4"x4"s can be used as a divider. Alternatively, staked straw bales wrapped with filter fabric (geotextile) may be used. If the pond is more than 6 feet deep, a different mechanism must be proposed. A riprap embankment is one acceptable method of separation for deeper ponds. Other designs that satisfy the intent of



this provision are allowed as long as the divider is permeable, structurally sound, and designed to prevent erosion under or around the barrier.

To aid in determining sediment depth, **one-foot intervals** shall be prominently marked on the riser.

If an **embankment** of more than 6 feet is proposed, the pond must comply with the criteria contained in Volume III regarding dam safety for detention BMPs.

- The most common structural failure of sedimentation basins is caused by piping. Piping refers to two phenomena: (1) water seeping through fine-grained soil, eroding the soil grain by grain and forming pipes or tunnels; and, (2) water under pressure flowing upward through a granular soil with a head of sufficient magnitude to cause soil grains to lose contact and capability for support.

The most critical construction sequences to prevent piping will be:

1. Tight connections between riser and barrel and other pipe connections.
2. Adequate anchoring of riser.
3. Proper soil compaction of the embankment and riser footing.
4. Proper construction of anti-seep devices.

***Maintenance Standards***

- Sediment shall be removed from the pond when it reaches 1-foot in depth.
- Any damage to the pond embankments or slopes shall be repaired.

# BMP C251: Construction Stormwater Filtration

## *Purpose*

Filtration removes sediment from runoff originating from disturbed areas of the site.

## *Background Information:*

Filtration with sand media has been used for over a century to treat water and wastewater. The use of sand filtration for treatment of stormwater has developed recently, generally to treat runoff from streets, parking lots, and residential areas. The application of filtration to construction stormwater treatment is currently under development.

## *Conditions of Use*

Traditional BMPs used to control soil erosion and sediment loss from sites under development may not be adequate to ensure compliance with the water quality standard for turbidity in the receiving water. Filtration may be used in conjunction with gravity settling to remove sediment as small as fine silt (0.5  $\mu\text{m}$ ). The reduction in turbidity will be dependent on the particle size distribution of the sediment in the stormwater. In some circumstances, sedimentation and filtration may achieve compliance with the water quality standard for turbidity.

The use of construction stormwater filtration does not require approval from Ecology as long as treatment chemicals are not used. Filtration in conjunction with polymer treatment requires testing under the Chemical Technology Assessment Protocol – Ecology (CTAPE) before it can be initiated. Approval from the appropriate regional Ecology office must be obtained at each site where polymers use is proposed prior to use. For more guidance on stormwater chemical treatment see [BMP C250: Construction Stormwater Chemical Treatment](#).

## *Design and Installation Specifications*

Two types of filtration systems may be applied to construction stormwater treatment: rapid and slow. Rapid sand filters are the typical system used for water and wastewater treatment. They can achieve relatively high hydraulic flow rates, on the order of 2 to 20 gpm/sf, because they have automatic backwash systems to remove accumulated solids. In contrast, slow sand filters have very low hydraulic rates, on the order of 0.02 gpm/sf, because they do not have backwash systems. Slow sand filtration has generally been used to treat stormwater. Slow sand filtration is mechanically simple in comparison to rapid sand filtration but requires a much larger filter area.

**Filtration Equipment.** Sand media filters are available with automatic backwashing features that can filter to 50  $\mu\text{m}$  particle size. Screen or bag filters can filter down to 5  $\mu\text{m}$ . Fiber wound filters can remove

particles down to 0.5 µm. Filters should be sequenced from the largest to the smallest pore opening. Sediment removal efficiency will be related to particle size distribution in the stormwater.

**Treatment Process Description.** Stormwater is collected at interception point(s) on the site and is diverted to an untreated stormwater sediment pond or tank for removal of large sediment and storage of the stormwater before it is treated by the filtration system. The untreated stormwater is pumped from the trap, pond, or tank through the filtration system in a rapid sand filtration system. Slow sand filtration systems are designed as flow through systems using gravity.

### ***Maintenance Standards***

Rapid sand filters typically have automatic backwash systems that are triggered by a pre-set pressure drop across the filter. If the backwash water volume is not large or substantially more turbid than the untreated stormwater stored in the holding pond or tank, backwash return to the untreated stormwater pond or tank may be appropriate. However, other means of treatment and disposal may be necessary.

- Screen, bag, and fiber filters must be cleaned and/or replaced when they become clogged.
- Sediment shall be removed from the storage and/or treatment ponds as necessary. Typically, sediment removal is required once or twice during a wet season and at the decommissioning of the ponds.

### **Sizing Criteria for Flow-Through Treatment Systems for Flow Control Exempt Water Bodies:**

When sizing storage ponds or tanks for flow-through systems for flow control exempt water bodies the treatment system capacity should be a factor. The untreated stormwater storage pond or tank should be sized to hold 1.5 times the runoff volume of the 10-year, 24-hour storm event minus the treatment system flowrate for an 8-hour period. For a chitosan-enhanced sand filtration system, the treatment system flowrate should be sized using a hydraulic loading rate between 6-8 gpm/ft<sup>2</sup>. Other hydraulic loading rates may be more appropriate for other systems. Bypass should be provided around the chemical treatment system to accommodate extreme storms. Runoff volume shall be calculated using the methods presented in [Chapter III-2 - Hydrologic Analysis](#). Worst-case conditions (i.e., producing the most runoff) should be used for analyses (most likely conditions present prior to final landscaping).

### **Sizing Criteria for Flow Control Water Bodies:**

Sites that must implement flow control for the developed site condition must also control stormwater release rates during construction. Construction site stormwater discharges shall not exceed the discharge durations of the pre-developed condition for the range of pre-developed discharge rates from 1/2 of the 2-year flow through the 10-year flow as predicted by an approved continuous runoff model.

The pre-developed condition to be matched shall be the land cover condition immediately prior to the development project. This restriction on release rates can affect the size of the storage pond, the filtration system, and the flow rate through the filter system.

The following is how WWHM can be used to determine the release rates from the filtration systems:

1. Determine the pre-developed flow durations to be matched by entering the land use area under the “Pre-developed” scenario in WWHM. The default flow range is from  $\frac{1}{2}$  of the 2-year flow through the 10-year flow.
2. Enter the post developed land use area in the “Developed Unmitigated” scenario in WWHM.
3. Copy the land use information from the “Developed Unmitigated” to “Developed Mitigated” scenario.
4. There are two possible ways to model stormwater filtration systems:
  - a. The stormwater filtration system uses an untreated stormwater storage pond/tank and the discharge from this pond/tank is pumped to one or more filters. In-line filtration chemicals would be added to the flow right after the pond/tank and before the filter(s). Because the discharge is pumped, WWHM can’t generate a stage/storage /discharge (SSD) table for this system. This system is modeled the same way as described in [BMP C250: Construction Stormwater Chemical Treatment](#) and is as follows:

While in the “Developed Mitigated” scenario, add a pond element under the basin element containing the post-developed land use areas. This pond element represents information on the available untreated stormwater storage and discharge from the filtration system. In cases where the discharge from the filtration system is controlled by a pump, a stage/storage/discharge (SSD) table representing the pond must be generated outside WWHM and imported into WWHM. WWHM can route the runoff from the post-developed condition through this SSD table (the pond) and determine compliance with the flow duration standard. This would be an iterative design procedure where if the initial SSD table proved to be out of compliance, the designer would have to modify the SSD table outside WWHM and re-import in WWHM and route the runoff through it again. The iteration will continue until a pond that enables compliance with the flow duration standard is designed.

Notes on SSD table characteristics:

- The pump discharge rate would likely be initially set at just below  $\frac{1}{2}$  if the 2-year flow from the pre-developed condition. As runoff coming into the untreated stormwater storage pond increases and the available untreated stormwater storage volume gets used up, it would be necessary to increase the pump discharge rate above  $\frac{1}{2}$  of the 2-year. The increase(s) above  $\frac{1}{2}$  of the 2-year must be such that they provide some relief to the untreated stormwater storage needs but at the same time they will not cause violations of the flow duration standard at the higher flows. The final design SSD table will identify the appropriate pumping rates and the corresponding stage and storages.
  - When building such a flow control system, the design must ensure that any automatic adjustments to the pumping rates will be as a result of changes to the available storage in accordance with the final design SSD table.
- b. The stormwater filtration system uses a storage pond/tank and the discharge from this pond/tank gravity flows to the filter. This is usually a slow sand filter system and it is possible to model it in WWHM as a Filter element or as a combination of Pond and Filter element placed in series. The stage/storage/discharge table(s) may then be generated within WWHM as follows:
- i. While in the “Developed Mitigated” scenario, add a Filter element under the basin element containing the post-developed land use areas. The length and width of this filter element would have to be the same as the bottom length and width of the upstream untreated stormwater storage pond/tank.
  - ii. In cases where the length and width of the filter is not the same as those for the bottom of the upstream untreated stormwater storage tank/pond, the treatment system may be modeled as a Pond element followed by a Filter element. By having these two elements, WWHM would then generate a SSD table for the storage pond which then gravity flows to the Filter element. The Filter element downstream of the untreated stormwater storage pond would have a storage component through the media, and an overflow component for when the filtration capacity is exceeded.

WWHM can route the runoff from the post-developed condition through the treatment systems in 4b and determine compliance with the flow duration standard. This would be an iterative design procedure where if the initial sizing estimates for the treatment system proved to be inadequate, the designer would

have to modify the system and route the runoff through it again. The iteration would continue until compliance with the flow duration standard is achieved.

5. It should be noted that the above procedures would be used to meet the flow control requirements. The filtration system must be able to meet the runoff treatment requirements. It is likely that the discharge flow rate of ½ of the 2-year or more may exceed the treatment capacity of the system. If that is the case, the untreated stormwater discharge rate(s) (i.e., influent to the treatment system) must be reduced to allow proper treatment. Any reduction in the flows would likely result in the need for a larger untreated stormwater storage volume.

If system design does not allow you to discharge at the slower rates as described above and if the site has a retention or detention pond that will serve the planned development, the discharge from the treatment system may be directed to the permanent retention/detention pond to comply with the flow control requirements. In this case, the untreated stormwater storage pond and treatment system will be sized according to the sizing criteria for flow-through treatment systems for flow control exempt waterbodies described earlier except all discharges (water passing through the treatment system and stormwater bypassing the treatment system) will be directed into the permanent retention/detention pond. If site constraints make locating the untreated stormwater storage pond difficult, the permanent retention/detention pond may be divided to serve as the untreated stormwater discharge pond and the post-treatment flow control pond. A berm or barrier must be used in this case so the untreated water does not mix with the treated water. Both untreated stormwater storage requirements, and adequate post-treatment flow control must be achieved. The post-treatment flow control pond's revised dimensions must be entered into the WWHM and the WWHM must be run to confirm compliance with the flow control requirement.

---

*Washington State Department of Ecology*

[2012 Stormwater Management Manual for Western Washington, as Amended in December 2014. \(The 2014 SWMMWW\)](#)